

Anritsu envision : ensure

VectorStar™

High Performance, Broadband Network Analysis Solutions

ME7838G Series Vector Network Analyzers

Broadband VNA System
Millimeter Waveguide VNA System

70 kHz to 220 GHz
50 GHz to 1.1 THz

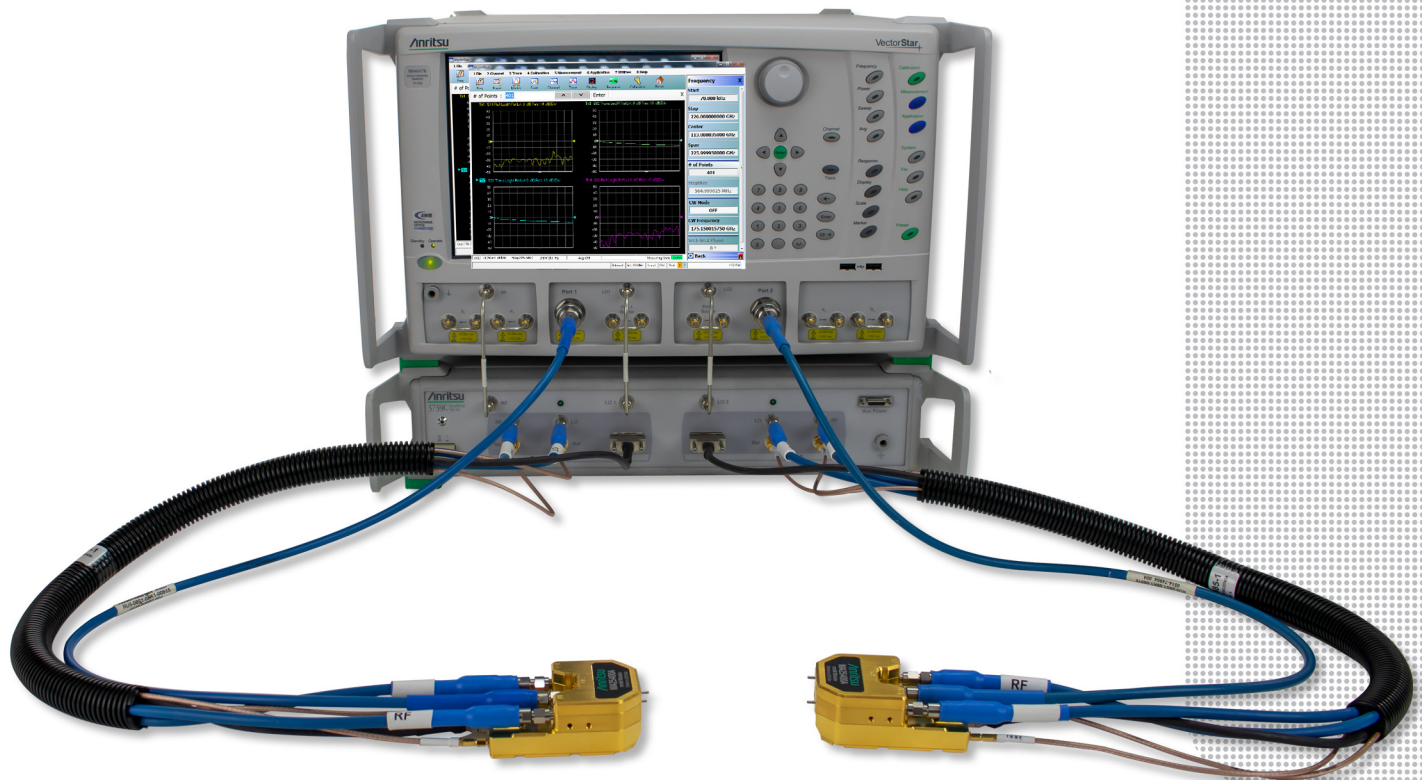

Introduction

Through the use of a novel coaxial-mode interface connector and advanced transceivers, broadband frequency coverage beyond 220 GHz is now possible. The ME7838G allows a continuous, broadband frequency sweep from 70 kHz to 220 GHz without the need to concatenate multiple systems (operational from 40 kHz to 226 GHz). The result is more accurate device characterization from near-DC through the W band and F band frequencies. W band devices can now be characterized beyond the operating frequency of the application for more accurate modeling and higher success rate from the first design turn. The ME7838G fully supports the 3744A-Rx 30 GHz to 125 GHz receiver for noise figure measurements up to 125 GHz. Integrating Anritsu's unique strength in nonlinear transmission line technology (NLTL), the ME7838G system offers many advances in broadband performance over traditional systems including:

- Industry-best broadband frequency coverage, starts at 70 kHz instead of 10 MHz and is operational from 40 kHz to 226 GHz through a single coaxial-mode connector
- Industry-best dynamic range, 120 dB at 10 MHz, 112 dB at 67 GHz, 108 dB at 110 GHz, and 100 dB at 145 GHz
- Industry-best measurement speed, 310 ms for 401 points at 10 kHz IFBW
- Compact, lightweight mm-Wave modules for easy, precise, and economical positioning on the wafer probe station, 0.6 lb and 1/50 the volume of traditional mm-wave modules
- The first millimeter-wave system with real time leveling of power without the need for calibration software correction tables
- Industry-best calibration and measurement stability, 0.1 dB over 24 hrs
- Fully supports tri-axial Kelvin bias tee connections for on-wafer device biasing up to 220 (226) GHz
- Millimeter-wave waveguide coverage to 1.1 THz
- The ME7838A 110/125 GHz and ME7838D 145 GHz Broadband systems can be easily upgraded to 220 GHz by incorporating the new Anritsu MA25400A mm-wave module

Broadband VNA System 70 kHz to 220 GHz

The ME7838G broadband VNA system provides single sweep coverage from 70 kHz to 220 GHz and is operational from 40 kHz to 226 GHz. It consists of the following items:

- MS4647B VectorStar™ VNA, 70 kHz to 70 GHz with Option 7, Option 70, and Option 80/81
- 3739C Broadband Millimeter-Wave Test Set and Interface Cables
- MA25400A Millimeter-Wave Module, 2 each
- Accessory kit (2000-1956-R) including an interface thru (for connecting between modules), two 1 mm (M) to interface adapters, a 1 mm F-F adapter, extra flange screws, and a torque wrench. See the accessories section for other available adapters.

Millimeter Waveguide VNA System 50 GHz to 1.1 THz

The ME7838G Millimeter-wave configuration provides waveguide output from 50 GHz to 1.1 THz in waveguide bands. The system can extend the broadband system or be configured to operate only as a waveguide system. It consists of the following items:

- MS4647B VectorStar™ VNA, 70 kHz to 70 GHz with Option 7, and Option 82/83
- 3739C Broadband Millimeter-Wave Test Set and Interface Cables
- Millimeter-Wave Module, 2 each
- Accessory kit (2000-1956-R) including an interface thru (for connecting between modules), two 1 mm (M) to interface adapters, a 1 mm F-F adapter, extra flange screws, and a torque wrench. See the accessories section for other available adapters.

Broadband/Millimeter-Wave System Options

- MS4640B-002 – Time Domain
- MS4640B-021 – Universal Fixture Extraction
- MS464xB-031 – Dual Source Architecture
- MS464xB-032 – Internal RF Combiner
- MS4640B-035 – IF Digitizer
- MS4640B-036 – Extended IF Digitizer Memory
- MS4640B-041 – Noise Figure
- MS4640B-042 – PulseView™
- MS4640B-043 – DifferentialView™
- MS4640B-044 – IMDView™
- MS4640B-046 – Fast CW
- MS4640B-047 – Eye Diagram
- MS464xB-051 – External VNA Direct Access Loops
- MS464xB-061 – Active Measurement Suite, with 2 Attenuators
- MS464xB-062 – Active Measurement Suite, with 4 Attenuators
- 3744E-Rx – 30 to 110 GHz mm-Wave Receiver for Noise Figure and mm-Wave Antenna Measurements
- 3744E-EE – 56 to 95 GHz WR-12 Waveguide Module
- 3744E-EW – 65 to 110 GHz WR-10 Waveguide Module
- SC8215 and SC7287 – Kelvin Bias Tees

A detailed color brochure available on the Anritsu web site provides descriptions and examples of the VectorStar family's features and benefits:

(<http://www.anritsu.com/en-us/products-solutions/products/ms4640b-series.aspx>)

Table of Contents

Introduction 2
 Definitions. 3
 Specifications for Broadband Configuration. 4
 Broadband Measurement Examples 15
 Specifications for Waveguide Band Configuration. 19
 VectorStar ME7838G Waveguide Bands from 50 GHz to 1.1 THz 22
 Standard Capabilities for All Configurations. 26
 Mechanical and Environmental. 26
 Regulatory Compliance. 26
 Warranty 26
 Calibration and Correction Capabilities 27
 Mechanical Calibration/Verification Kits 28
 Test Port Cables 30
 Information on Using MA25400A-specific Adapters 30
 Precision Adapters, Attenuators, and Other Components 31
 Ordering Information 32

Definitions

All specifications and characteristics apply under the following conditions, unless otherwise stated:

Warm-Up Time	After 90 minutes of warm-up time, where the instrument is left in the ON state.
Temperature Range	Over the 25 °C ± 5 °C temperature range.
Error-Corrected Specifications	Error-corrected specifications: over 23 °C ± 3 °C, with < 1 °C variation from calibration temperature. Error-corrected specifications are warranted and include guard bands, unless otherwise stated.
Typical Performance	"Typical" specifications describe expected, but not warranted, performance based on sample testing. Typical performance indicates the measured performance of an average unit and do not guarantee the performance of any individual product. "Typical" specifications do not account for measurement uncertainty and are shown in parenthesis, such as (-102 dB), or noted as Typical.
User Cables/Adapters	Specifications do not include effects of any user cables, adapters, fixtures or other structures attached to the instrument.
Discrete Spurious Responses	Specifications may exclude discrete spurious responses.
Internal Reference Signal	All specifications apply with internal 10 MHz Crystal Oscillator Reference Signal.
Characteristic Performance	Characteristic performance indicates a performance designed-in and verified during the design phase. It does include guard-bands and is not covered by the product warranty.
Below 300 kHz	All uncertainties below 300 kHz are typical.
Recommended Calibration Cycle	12 months
Interpolation Mode	All specifications are with Interpolation Mode Off.
Specifications Subject to Change	All specifications subject to change without notice. For the most current data sheet, please visit the Anritsu web site at www.anritsu.com .

The instrument may be protected by one or more of the following patents: 6894581, 7088111, 7545151, 7683633, 7924024, 8185078, 8306134, 8417189, 8718586, 9103873, 9606212, 9753071, 10225073 depending upon the model and option configuration of the instrument.

Specifications for Broadband Configuration

ME7838G Broadband Hardware Configuration

The ME7838G broadband VNA system provides single sweep coverage from 70 kHz to 220 GHz and is operational from 40 kHz to 226 GHz. It consists of the following items:

VNA	MS4647B VectorStar VNA, 70 kHz to 70 GHz with Option 7, Option 70, and Option 80/81/84/85
Test Set	3739C Broadband Test Set and interface cables
mm-Wave Modules	MA25400A Millimeter-Wave Module, 2 each

ME7838G Broadband/Millimeter-Wave System Options

The major ME7838G broadband VNA system options are:

Option 2	MS4640B-002 – Time Domain
Option 21	MS4640B-021 – Universal Fixture Extraction
Option 31	MS464xB-031 – Dual Source Architecture
Option 32	MS464xB-032 – Internal RF Combiner
Option 35	MS4640B-035 – IF Digitizer
Option 36	MS4640B-035 – Extended IF Digitizer Memory
Option 41	MS4640B-041 – Noise Figure
Option 42	MS4640B-042 – PulseView™
Option 43	MS4640B-043 – DifferentialView™
Option 44	MS4640B-044 – IMDView™
Option 46	MS4640B-046 – Fast CW
Option 47	MS4640B-047 – Eye Diagram
Option 51	MS464xB-051 – External VNA Direct Access Loops
Option 61	MS464xB-061 – Active Measurement Suite, with 2 Attenuators
Option 62	MS464xB-062 – Active Measurement Suite, with 4 Attenuators
Bias Tees	SC8215 and SC7287 – Kelvin Bias Tees

System and Receiver Dynamic Range, Noise Floor (Referenced to the coaxial mode flange interface on the MA25400A module)

System Dynamic Range	System dynamic range is measured as the difference between maximum port power and the RMS noise floor in a 10 Hz bandwidth and no averaging (ports terminated).
Noise Floor	Noise floor is calculated as the difference between maximum rated port power and system dynamic range.
Receiver Dynamic Range	Receiver Dynamic Range is calculated as the difference between the receiver compression level and the noise floor at Ports 1 or 2.
Normalizing Measurement	Normalizing measurement made with a through line connection, with its effects compensated for. The cables between the VNA and the MA25400A modules are assumed to be among those offered by Anritsu. All values are typical.

Frequency (GHz)	System Dynamic Range (dB) ^a		Receiver Dynamic Range (dB) ^a		Noise Floor (dBm) ^a	
	ME7838G	ME7838G Option 62	ME7838G	ME7838G Option 62	ME7838G	ME7838G Option 62
70 kHz to 300 kHz	93	90	89	88	-83	-82
> 0.3 to 2 MHz	103	100	103	104	-93	-92
> 2 to 10 MHz	115	112	115	114	-105	-102
> 0.01 to < 2.5	120	116	121	122	-110	-109
2.5 to 24	110	105	121	122	-110	-109
> 24 to 54	110	107	126	126	-116	-116
> 54 to 60	112	112	126	126	-116	-116
> 60 to 67	112	112	125	125	-115	-115
> 67 to 80	110	110	123	123	-113	-113
> 80 to 85	109	109	126	126	-116	-116
> 85 to 90	109	109	125	125	-115	-115
> 90 to 95	109	109	125	125	-115	-115
> 95 to 105	108	108	124	124	-114	-114
> 105 to 110	108	108	124	125	-114	-115
> 110 to 120	109	109	123	123	-116	-116
> 120 to 125	109	109	123	123	-116	-116
> 125 to 140	108	108	130	130	-123	-123
> 140 to 150	100	100	122	122	-115	-115
> 150 to 160	97	97	119	119	-112	-112
> 160 to 180	103	103	123	123	-116	-116
> 180 to 200	103	103	123	123	-116	-116
> 200 to 220	102	102	124	124	-117	-117
> 220 to 226	85	85	108	108	-103	-103

a. Excludes localized spurious responses and crosstalk.

System and Receiver Dynamic Range, Noise Floor (Referenced to the Probe Tip)

The definitions are the same as in the previous table, but the reference plane is now at the tip of an MPI model T220A probe. Results are characteristic. Other probes can be used, but the values below will not generally apply.

Frequency (GHz)	At the Probe Tip					
	System Dynamic Range (dB) ^a		Receiver Dynamic Range (dB) ^a		Noise Floor (dBm) ^a	
	ME7838G	ME7838G Option 62	ME7838G	ME7838G Option 62	ME7838G	ME7838G Option 62
70 kHz to 300 kHz	93	90	89	88	-83	-82
> 0.3 to 2 MHz	103	100	103	104	-93	-92
> 2 to 10 MHz	115	112	115	114	-105	-102
> 0.01 to < 2.5	119	115	120	121	-109	-108
2.5 to 24	108	103	121	122	-109	-108
> 24 to 54	107	104	127	127	-115	-115
> 54 to 60	110	110	128	128	-116	-116
> 60 to 67	110	110	127	127	-115	-115
> 67 to 80	107	107	124	124	-112	-112
> 80 to 85	105	105	123	123	-111	-111
> 85 to 90	105	105	125	125	-113	-113
> 90 to 95	105	105	125	125	-113	-113
> 95 to 105	104	104	123	123	-111	-111
> 105 to 110	103	103	123	123	-111	-111
> 110 to 120	104	104	122	122	-113	-113
> 120 to 125	104	104	122	122	-113	-113
> 125 to 140	103	103	131	131	-121	-121
> 140 to 150	94	94	122	122	-112	-112
> 150 to 160	91	91	119	119	-109	-109
> 160 to 180	97	97	123	123	-113	-113
> 180 to 200	97	97	123	123	-113	-113
> 200 to 220	93	93	125	125	-113	-113
> 220 to 226	74	74	109	109	-98	-98

a. Excludes localized spurious responses and crosstalk.

Test Port Power, Receiver Compression (Referenced to the coaxial-mode flange interface on the MA25400A module)

Port power control is provided by the base VNA for frequencies below 54 GHz, and by the MA25400A mm-Wave module for frequencies greater than 54 GHz. Receiver compression point is defined as the port power level beyond which the response may be compressed more than 0.2 dB relative to normalization level. 10 Hz IF bandwidth used to remove high level noise effects. Power measured with traditional thermal power sensors below 125 GHz and with a calibrated calorimeter-style power meter at higher frequencies. All values are typical.

Frequency (GHz)	Port Power (dBm)		Receiver Compression ^a	
	Max Power ME7838G	Max Power ME7838G Option 62 ^b	Compression ME7838G	Compression ME7838G Option 62
70 kHz to 300 kHz	10	8	6	6
> 0.3 to 2 MHz	10	8	10	12
> 2 to 10 MHz	10	10	10	12
> 0.01 to < 2.5	10	7	11	13
2.5 to 24	0	-4	11	13
> 24 to 54	-6	-9	10	10
> 54 to 60	-4	-4	10	10
> 60 to 67	-3	-3	10	10
> 67 to 80	-3	-3	10	10
> 80 to 85	-7	-7	10	10
> 85 to 90	-6	-6	10	10
> 90 to 95	-6	-6	10	10
> 95 to 105	-6	-6	10	10
> 105 to 110	-6	-6	10	10
> 110 to 120	-7	-7	7	7
> 120 to 125	-7	-7	7	7
> 125 to 140	-15	-15	7	7
> 140 to 150	-15	-15	7	7
> 150 to 160	-15	-15	7	7
> 160 to 180	-13	-13	7	7
> 180 to 200	-13	-13	7	7
> 200 to 220	-15	-15	7	7
> 220 to 226	-18	-18	5	5

a. Using the 806-209-R 1.85 mm (91.5 cm, 36 in long) test port cables between the VNA and the MA25400A mm-Wave modules.

b. Use this column also for Options 51 and 61 although the performance between 10 MHz and 54 GHz will characteristically be better by 1 dB or more for Option 51, and will characteristically be better by 1 dB or more for Option 61 (with port 1 driving and port 2 receiving).

Test Port Power, Receiver Compression (Referenced to the Probe Tip)

The definitions are the same as in the previous table, but the reference plane is now at the tip of an MPI model T220A probe. Results are characteristic. Other probes can be used, but the values below will not generally apply.

Frequency (GHz)	At the Probe Tip			
	Port Power (dBm)		Receiver Compression ^a	
	Max Power ME7838G	Max Power ME7838G Option 62 ^b	Compression ME7838G	Compression ME7838G Option 62
70 kHz to 300 kHz	10	8	6	6
> 0.3 to 2 MHz	10	8	10	12
> 2 to 10 MHz	10	10	10	12
> 0.01 to < 2.5	10	7	11	13
2.5 to 24	-1	-5	12	14
> 24 to 54	-8	-11	12	12
> 54 to 60	-6	-6	12	12
> 60 to 67	-5	-5	12	12
> 67 to 80	-5	-5	12	12
> 80 to 85	-6	-6	12	12
> 85 to 90	-8	-8	12	12
> 90 to 95	-8	-8	12	12
> 95 to 105	-7	-8	12	12
> 105 to 110	-8	-8	12	12
> 110 to 120	-9	-9	9	9
> 120 to 125	-9	-9	9	9
> 125 to 140	-18	-18	10	10
> 140 to 150	-18	-18	10	10
> 150 to 160	-18	-18	10	10
> 160 to 180	-16	-16	10	10
> 180 to 200	-16	-16	10	10
> 200 to 220	-20	-20	12	12
> 220 to 226	-24	-24	11	11

a. Using the 806-209-R 1.85 mm (91.5 cm, 36 in long) test port cables between the VNA and the MA25400A mm-Wave modules.

b. Use this column also for Options 51 and 61 although the performance between 10 MHz and 54 GHz will characteristically be better by 1 dB or more for Option 51, and will characteristically be better by 1 dB or more for Option 61 (with port 1 driving and port 2 receiving).

Power Range, Accuracy, Linearity, and Resolution (Referenced to the coaxial-mode flange interface on the MA25400A module)

Accuracy is defined at -10 dBm or max rated power, whichever is lower. Linearity is defined as the port power linearity error between the accuracy test power level and 5 dB below. Typical.

Frequency (GHz)	Range (dBm)		Accuracy (dB)	Linearity (dB)	Resolution (dB)
	ME7838G	ME7838G Option 62			
70 kHz to 300 kHz	-25 to +10	-85 to +8	±1.5	±1.5	0.01
> 0.3 to 2 MHz	-25 to +10	-85 to +8	±1.5	±1.5	0.01
> 2 to 10 MHz	-25 to +10	-85 to +10	±1.5	±1.5	0.01
> 0.01 to < 2.5	-25 to +10	-85 to +7	±1.5	±1.0	0.01
2.5 to 24	-25 to 0	-85 to -4	±1.5	±1.0	0.01
> 24 to 54	-30 to -6	-90 to -9	±1.5	±1.0	0.01
> 54 to 60	-55 to -4	-55 to -4	±2.0	±1.5	0.01
> 60 to 67	-55 to -3	-55 to -3	±2.0	±1.5	0.01
> 67 to 80	-55 to -3	-55 to -3	±2.0	±1.5	0.01
> 80 to 85	-55 to -7	-55 to -7	±2.0	±1.5	0.01
> 85 to 90	-55 to -6	-55 to -6	±2.0	±1.5	0.01
> 90 to 95	-55 to -6	-55 to -6	±2.0	±1.5	0.01
> 95 to 105	-55 to -6	-55 to -6	±3.0	±2.0	0.01
> 105 to 110	-55 to -6	-55 to -6	±3.0	±2.0	0.01
> 110 to 120	-55 to -7	-55 to -7	±4.0	±3.0	0.01
> 120 to 125	-55 to -7	-55 to -7	±4.0	±3.0	0.01
> 125 to 140	-50 to -15	-50 to -15	±4.0	±4.0	0.01
> 140 to 150	-50 to -15	-50 to -15	±4.0	±4.0	0.01
> 150 to 160	-50 to -15	-50 to -15	±4.0	±4.0	0.01
> 160 to 180	-50 to -13	-50 to -13	±4.0	±4.0	0.01
> 180 to 200	-50 to -13	-50 to -13	±4.0	±4.0	0.01
> 200 to 220	-50 to -15	-50 to -15	±4.0	±4.0	0.01
> 220 to 226	-50 to -18	-50 to -18	±5.0	±4.0	0.01

High Level Noise

Noise measured at the indicated IF bandwidth, at maximum power or compression limit (whichever is less), with through transmission. RMS. Typical.

Frequency Range (GHz)	1 kHz IF bandwidth		100 Hz IF bandwidth	
	Magnitude (dB)	Phase (deg.)	Magnitude (dB)	Phase (deg.)
70 kHz to 500 kHz	< 0.04	< 0.4	< 0.02	< 0.2
> 0.5 to 2 MHz	< 0.005	< 0.05	< 0.003	< 0.03
> 2 to 10 MHz	< 0.005	< 0.05	< 0.003	< 0.03
> 0.01 to < 2.5	< 0.005	< 0.05	< 0.003	< 0.03
2.5 to 24	< 0.006	< 0.06	< 0.003	< 0.03
> 24 to 54	< 0.007	< 0.08	< 0.005	< 0.05
> 54 to 80	< 0.007	< 0.09	< 0.005	< 0.06
> 80 to 110	< 0.008	< 0.09	< 0.005	< 0.06
> 110 to 120	< 0.008	< 0.09	< 0.006	< 0.06
> 120 to 125	< 0.011	< 0.11	< 0.006	< 0.07
> 125 to 140	< 0.015	< 0.15	< 0.006	< 0.07
> 140 to 150	< 0.015	< 0.15	< 0.006	< 0.07
> 150 to 160	< 0.02	< 0.2	< 0.01	< 0.1
> 160 to 180	< 0.025	< 0.25	< 0.009	< 0.09
> 180 to 200	< 0.025	< 0.25	< 0.009	< 0.09
> 200 to 220	< 0.07	< 0.5	< 0.04	< 0.3
> 220 to 226	< 0.2	< 0.8	< 0.05	< 0.5

Stability

Measurement ratio at maximum leveled power and with a stable thru (flange interface-based) over the normal specified temperature range. Assumes the setup is mechanically stable and settled and is based on ambient temperature shifts. Measured in a 100 Hz IF bandwidth. (23 °C ±3°C Typical)

Frequency Range (GHz)	Magnitude (dB/°C)	Phase (deg./°C)
70 kHz to 300 kHz	< 0.015	< 0.1
> 0.3 to 2 MHz	< 0.015	< 0.05
> 2 to 10 MHz	< 0.01	< 0.05
> 0.01 to < 2.5	< 0.01	< 0.05
2.5 to 30	< 0.01	< 0.09
> 30 to 54	< 0.01	< 0.07
> 54 to 80	< 0.015	< 0.1
> 80 to 110	< 0.015	< 0.15
> 110 to 120	< 0.02	< 0.2
> 120 to 125	< 0.025	< 0.2
> 125 to 140	< 0.025	< 0.3
> 140 to 150	< 0.025	< 0.5
> 150 to 160	< 0.04	< 0.5
> 160 to 180	< 0.04	< 0.5
> 180 to 200	< 0.04	< 0.5
> 200 to 220	< 0.04	< 0.5
> 220 to 226	< 0.06	< 0.7

Frequency Resolution, Accuracy, and Stability

Resolution	Accuracy	Stability
1 Hz	±5 x 10 ⁻⁷ Hz/Hz (at time of calibration)	< 5 x 10 ⁻⁹ /°C over 0 °C to 50 °C temperature < 1 x 10 ⁻⁹ /day aging, instrument on

Uncorrected (Raw) Port Characteristics (Referenced to the coaxial-mode flange interface of the MA25400A module)
 Typical performance with either ME7838G or ME7838G with Option 62.

Frequency Range (GHz)	Port Match (dB)
70 kHz to 10 MHz	8
> 0.01 to < 2.5	10
2.5 to 30 ^a	11
> 30 to 40 ^a	11
> 40 to 54	11
> 54 to 80	10
> 80 to 110	7
> 110 to 120	7
> 120 to 125	7
> 125 to 140	7
> 140 to 150	5
> 150 to 160	5
> 160 to 180	5
> 180 to 200	5
> 200 to 220	5

a. Port match is degraded in narrow bands between 20 and 40 GHz.

Corrected System Performance and Uncertainties – SOLT/SSST

With 12-term concatenated SOLT and Triple Offset Short Calibration (SSST), using the 3659 0.8 mm Calibration Kit. Typical.

Frequency Range (GHz)	Directivity (dB)	Source Match (dB)	Load Match (dB)	Reflection Tracking (dB)	Transmission Tracking (dB)
70 kHz to 10 MHz	36	36	36	± 0.1	± 0.1
> 0.01 to < 2.5	38	41	38	± 0.05	± 0.03
2.5 to 20	40	41	40	± 0.05	± 0.05
> 20 to 67	35	41	35	± 0.05	± 0.07
> 67 to 80	35	38	35	± 0.05	± 0.07
> 80 to 95	35	40	35	± 0.05	± 0.07
> 95 to 110	34	37	34	± 0.05	± 0.07
> 110 to 125	30	34	30	± 0.07	± 0.09
> 125 to 140	28	28	28	± 0.09	± 0.11
> 140 to 145	26	28	26	± 0.11	± 0.13

Measurement Uncertainties – SOLT/SSST

The graphs give measurement uncertainties after the above calibration at a port power of -18 dBm. The component uncertainties are combined based on their characteristics: residual directivity, load and source match, tracking, network analyzer dynamic accuracy and connector repeatability are assumed to be fully correlated while noise effects (high level noise and noise floor effects) are assumed to be internally uncorrelated and uncorrelated with the first group of terms. 10 Hz IF Bandwidth is used. For transmission uncertainties, it is assumed that $S_{11} = S_{22} = 0$. For reflection uncertainties, it is assumed that $S_{21} = S_{12} = 0$. For other conditions, please use our free Exact Uncertainty calculator software, downloadable from the Anritsu web site at www.anritsu.com.

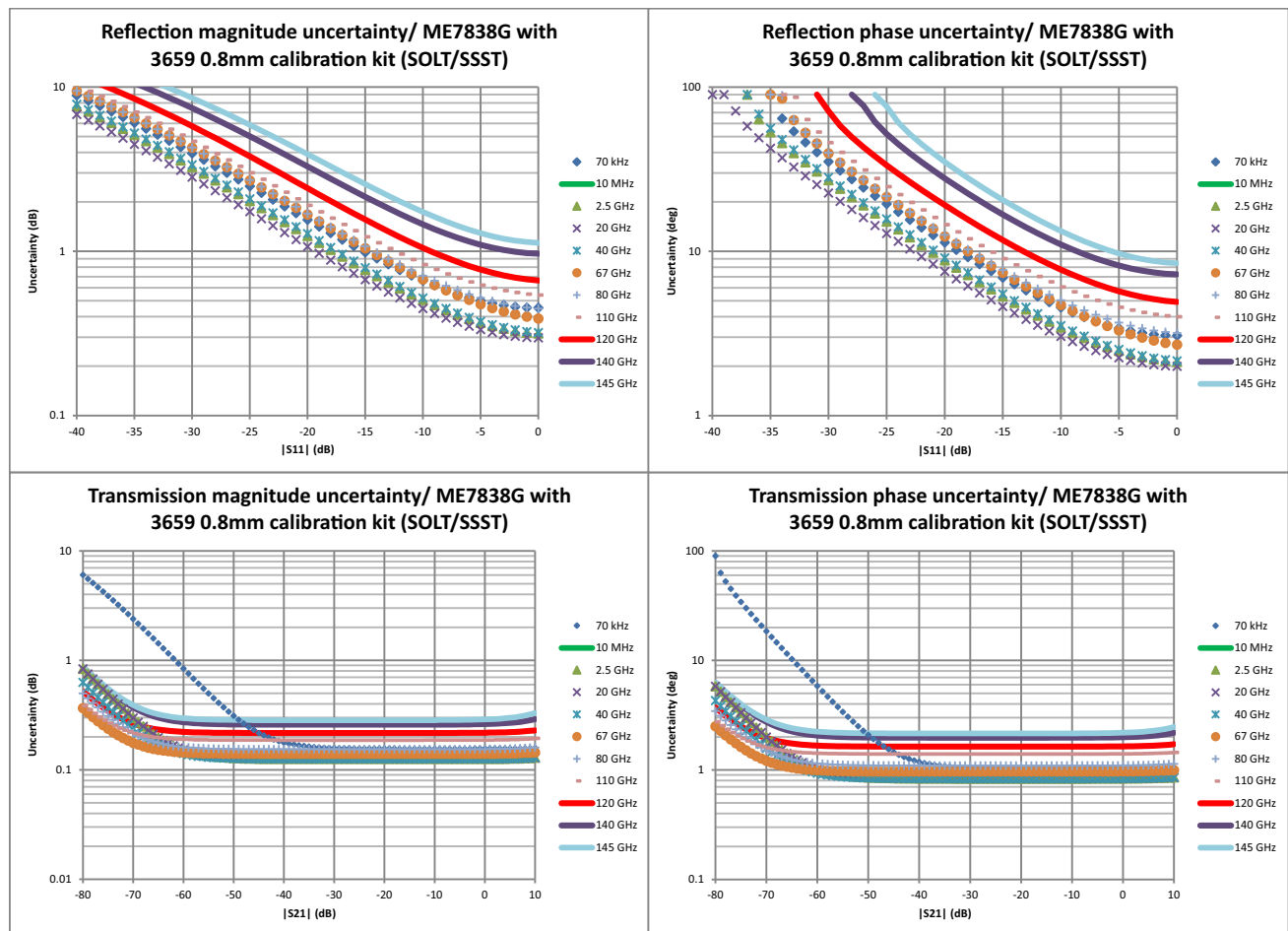

Corrected System Performance and Uncertainties – SOLT/SSST

With 12-term concatenated SOLT and Triple Offset Short Calibration (SSST), using the 3656B W1 Calibration Kit. Typical.

Frequency (GHz)	Directivity (dB)	Source Match (dB)	Load Match (dB)	Reflection Tracking (dB)	Transmission Tracking (dB)
70 kHz to 10 MHz	36	36	36	± 0.1	± 0.1
> 0.01 to < 2.5	40	41	40	± 0.05	± 0.03
2.5 to 20	40	41	40	± 0.05	± 0.05
> 20 to 67	38	41	38	± 0.05	± 0.07
> 67 to 95	37	42	37	± 0.05	± 0.07
> 95 to 110	35	35	35	± 0.05	± 0.07

Measurement Uncertainties – SOLT/SSST

The graphs give measurement uncertainties after the above calibration at port power of -10dBm. The errors are worst case contribution of residual directivity, load and source match, frequency response and isolation, network analyzer dynamic accuracy, and connector repeatability while noise effects are added on an RSS basis. 10 Hz IF Bandwidth is used. For transmission uncertainties, it is assumed that $S_{11} = S_{22} = 0$. For reflection uncertainties, it is assumed that $S_{21} = S_{12} = 0$. For other conditions, please use our free Exact Uncertainty calculator software, downloadable from the Anritsu web site at www.anritsu.com.

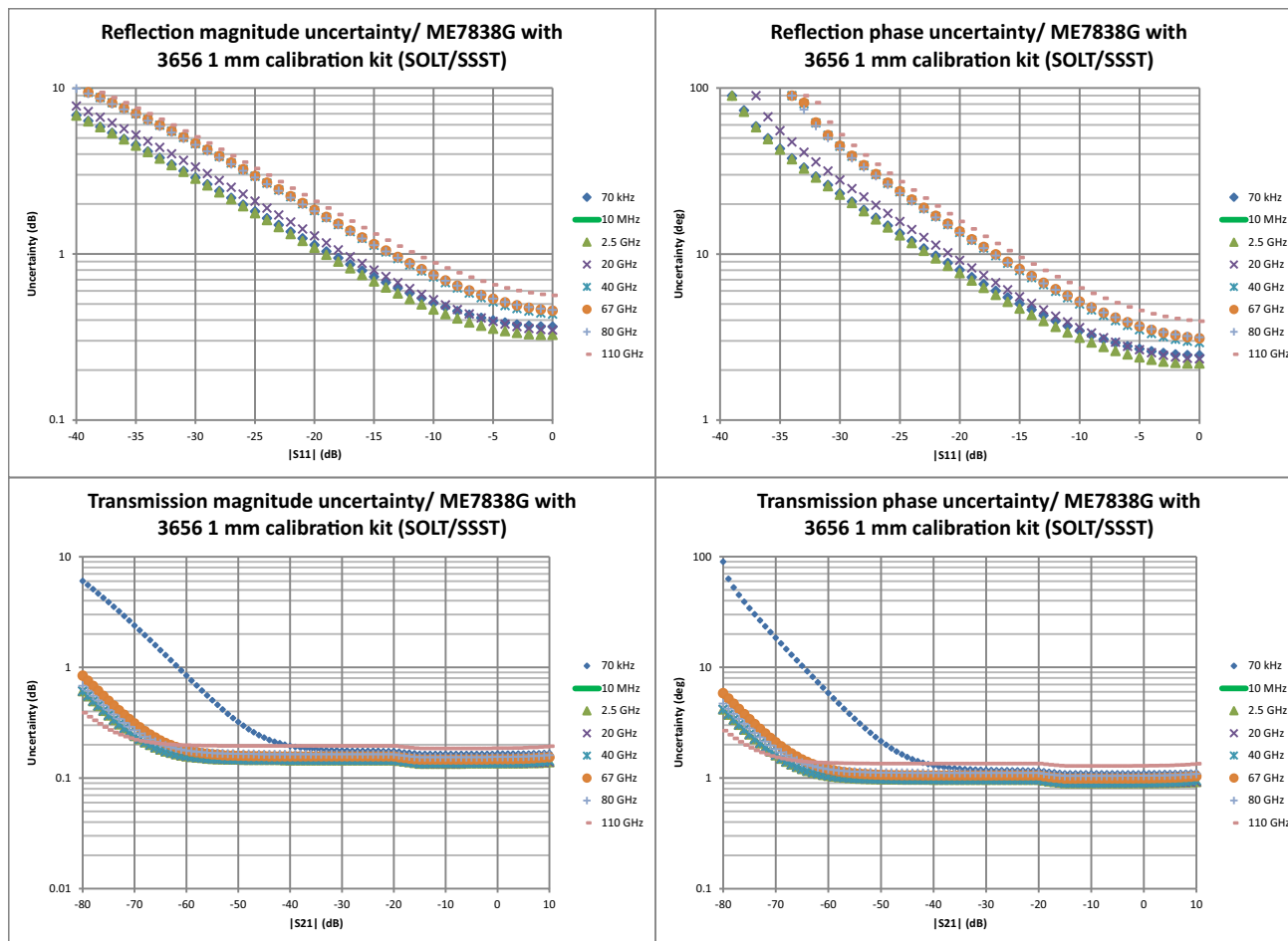

Corrected System Performance and Uncertainties – SOLT/SSST with .s1p Standards Definitions

With 12-term concatenated SOLT and Triple Offset Short Calibration (SSST), using the 3656B-3 W1 Calibration Kit. Typical values are in parentheses. Load match is limited by residual directivity. Cable flexure and drift effects are not included.

Frequency (GHz)	Directivity (dB)	Source Match (dB)	Load Match (dB)	Reflection Tracking (dB)	Transmission Tracking (dB)
70 kHz to 10 MHz	43 (50)	43 (50)	40 (43)	± 0.1	± 0.1
> 0.01 to < 2.5	43 (50)	43 (50)	40 (43)	± 0.05	± 0.03
2.5 to 20	43 (50)	43 (50)	40 (43)	± 0.05	± 0.05
> 20 to 67	42 (47)	42 (47)	39 (42)	± 0.05	± 0.07
> 67 to 95	40 (43)	41 (45)	37 (40)	± 0.05	± 0.07
> 95 to 110	38 (41)	40 (43)	35 (38)	± 0.05	± 0.07

Measurement Uncertainties – SOLT/SSST with .s1p Standards Definitions

The graphs give measurement uncertainties after the above calibration at port power of -10dBm. The errors are worst case contribution of residual directivity, load and source match, frequency response and isolation, network analyzer dynamic accuracy, and connector repeatability while noise effects are added on an RSS basis. 10 Hz IF Bandwidth is used. For transmission uncertainties, it is assumed that $S_{11} = S_{22} = 0$. For reflection uncertainties, it is assumed that $S_{21} = S_{12} = 0$. For other conditions, please use our free Exact Uncertainty calculator software, downloadable from the Anritsu web site at www.anritsu.com.

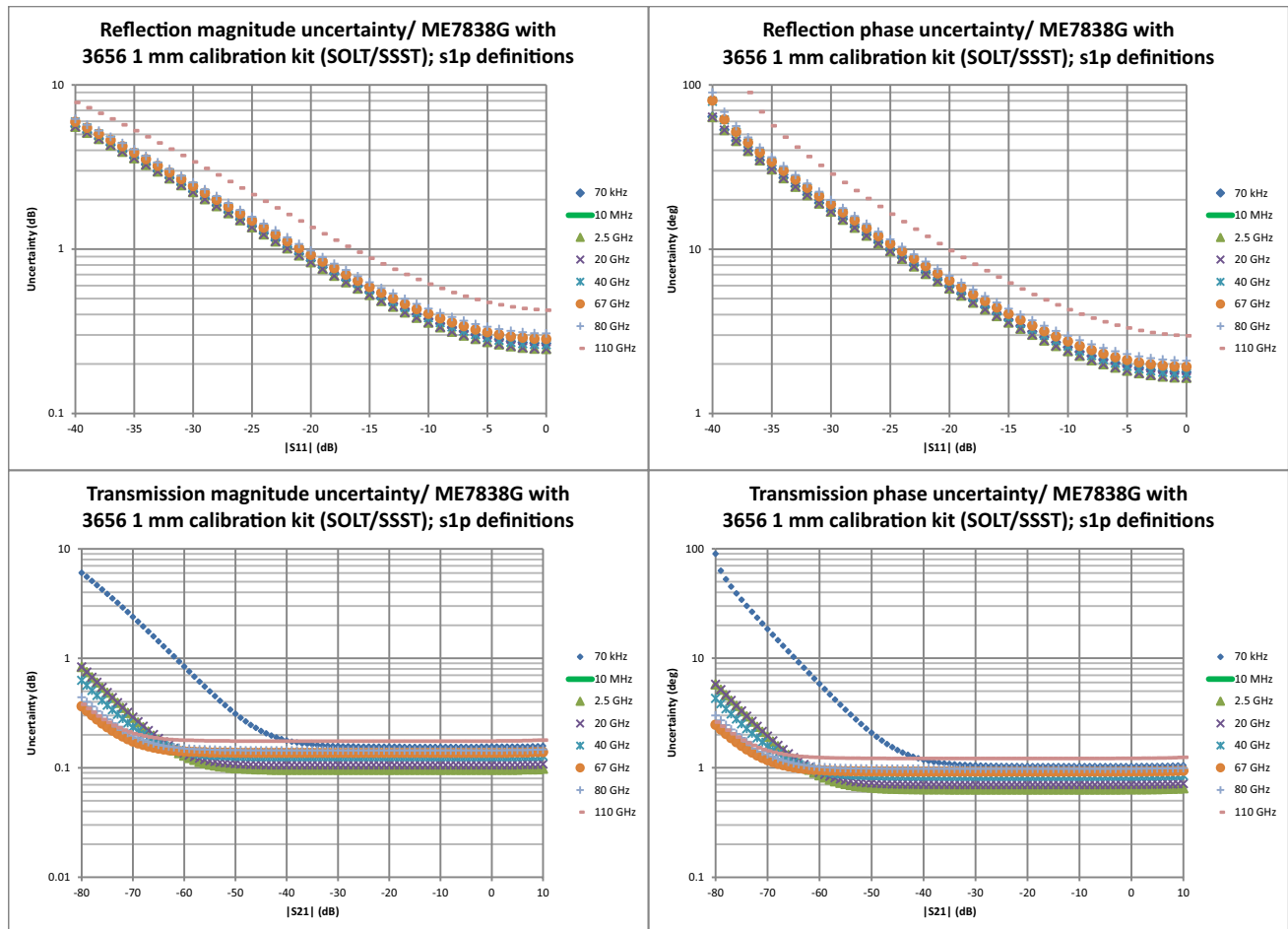

Corrected System Performance and Uncertainties - LRL/LRM

With 12 term LRL/LRM calibration using on-wafer substrate standards. Characteristic. Based on a typical vendor supplied impedance standard substrate. The uncertainty model includes probe crosstalk equivalent to a 300 μm air separation. Nominal contact repeatability terms are included based on experience with gold pads on alumina. Drift is not included. The Exact Uncertainty tool or other tools may be useful for evaluating uncertainties in specific scenarios.

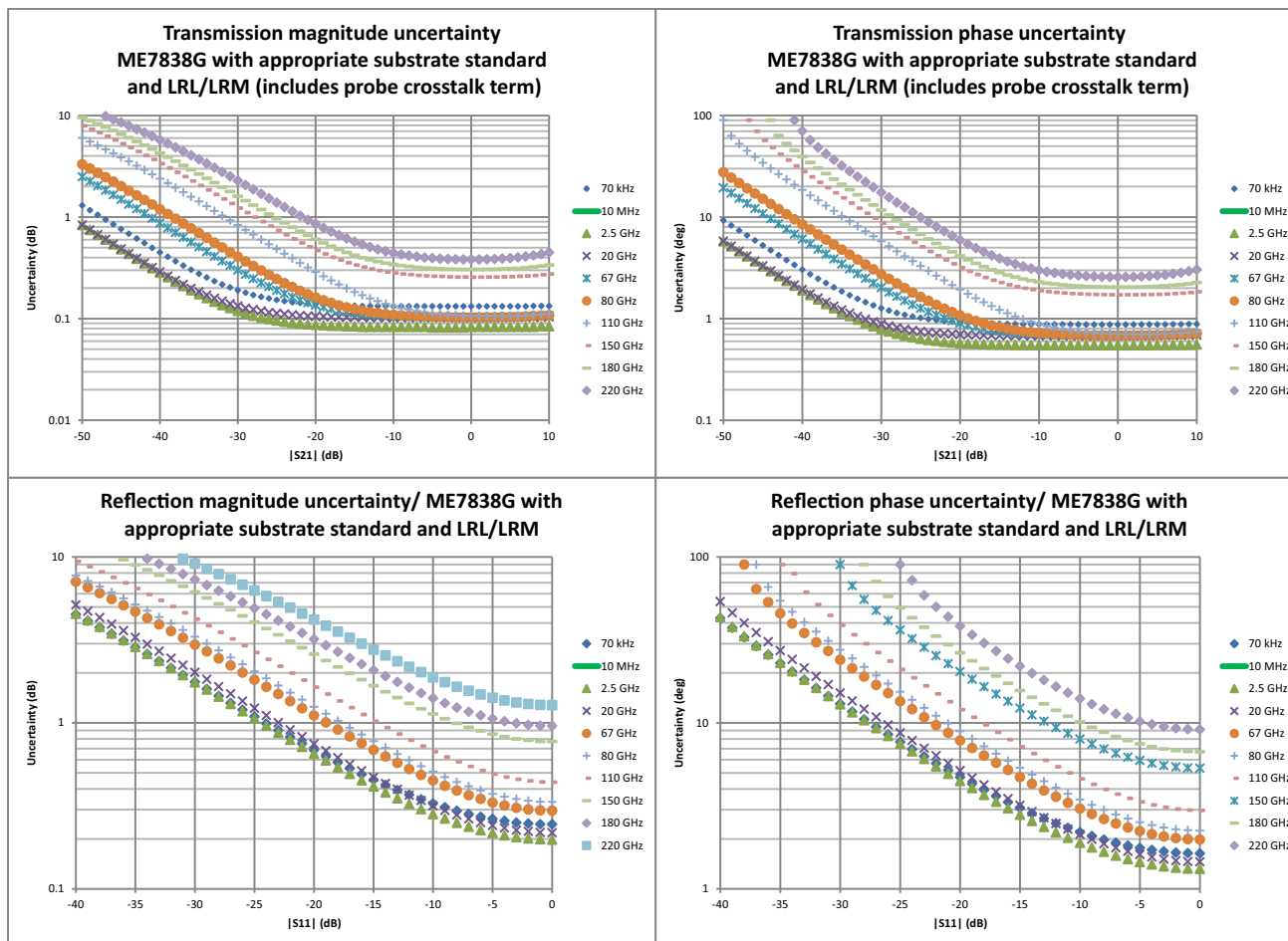

Measurement Time

Measurement times include sweep time, retrace time, and band-switching time. Typical.

Measurement Time (ms)

Full Band, 70 kHz to 220 GHz, Display ON, and ALC ON.

Calibration	IFBW	Measurement Time (ms) ^a			
		401 Points	1,601 Points	10,001 Points	25,000 Points
1-port calibration	1 MHz	280	370	800	2000
	30 kHz	290	410	1250	2500
	10 kHz	310	500	1800	3600
	1 kHz	650	1900	10,000	25,000
	10 Hz	39,000	150,000	950,000	2,400,000
2-port calibration	1 MHz	560	740	1600	4000
	30 kHz	580	820	2500	5000
	10 kHz	620	1000	3600	7200
	1 kHz	1300	3800	20,000	50,000
	10 Hz	78,000	300,000	1,900,000	4,800,000

a. Measurement times are for ME7838G Broadband and ME7838G Millimeter-Wave Systems.

Measurement Time (ms) vs. System Dynamic Range (dB)

Full Band, Display ON, and ALC ON.

Calibration	401 Points Measurement Time	Achieved System Dynamic Range (Opt 062 at 54 GHz)	IFBW and Averaging Used
Uncorrected or 1-port calibration	310	80	10 kHz/no avg
	650	90	1 kHz/no avg
2-port calibration	620	80	10 kHz/no avg
	1300	90	1 kHz/no avg

Block Diagram – ME7838G Broadband VNA System

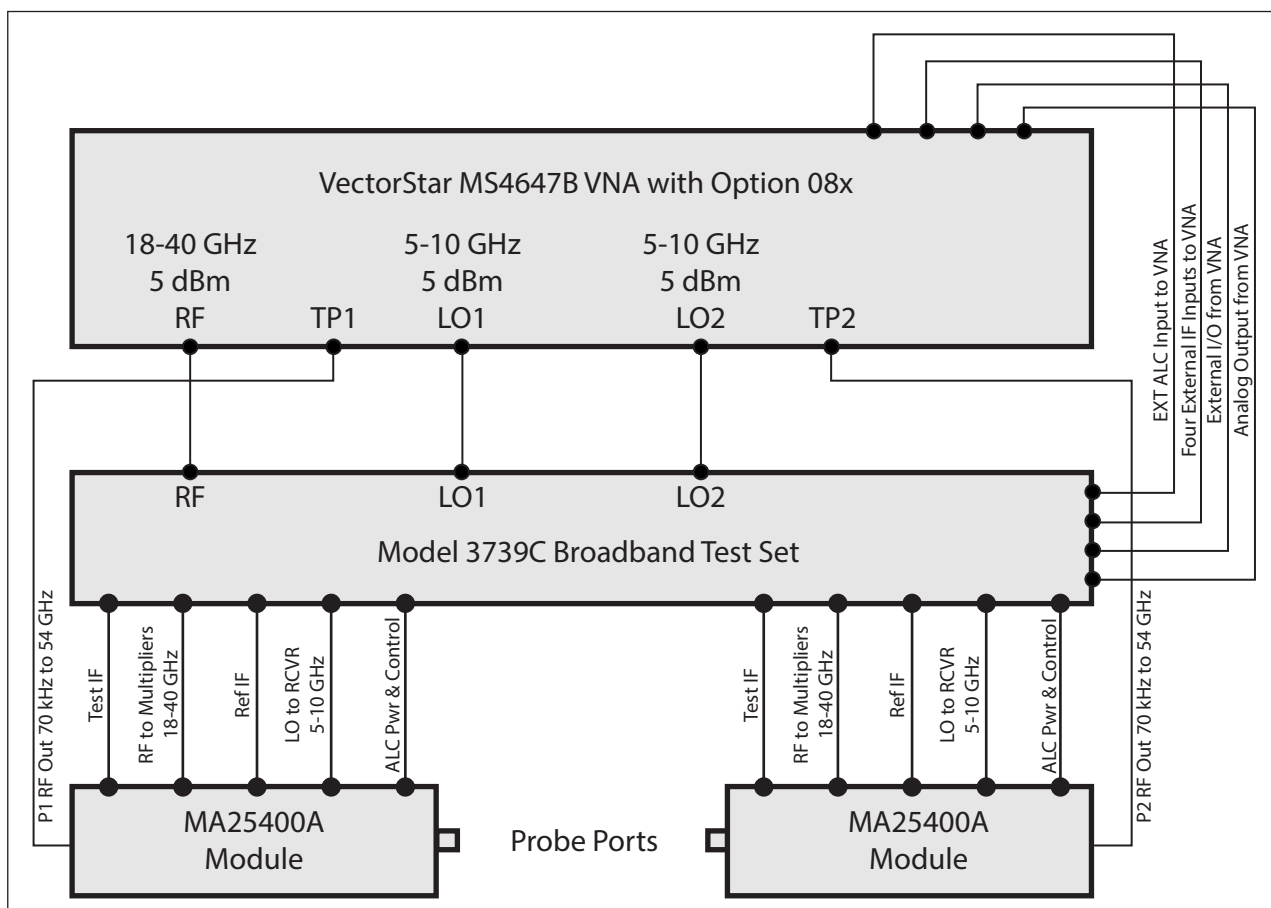

Broadband Configuration Block Diagram

SC8215 and SC7287 Kelvin Bias Tees

When connected to the Source input of the MA25400A module, provides Sense and Force SMC connections 1.5 in from the test port to minimize the IR drops associated with the impedances between the bias tee and the DUT.

Part Number	Description	Voltage	Current	Bias Leakage Current (avg, typ) (bias tee mounted on NLTL module) (typ. operating temp.)
SC8215	The SC8215 is a V-connectORIZED bias tee used at the rear of the module. This allows for bias while performing measurements from 70 kHz to the maximum frequency of the MA25400A module. Stand-alone, it is usable to 70 GHz.	Max Voltage: 16 VDC	Max Current: 100 mA	1 pA @ 1 VDC 16 pA @ 16 VDC
SC7287	The SC7287 is a V-connectORIZED bias tee used at the rear of the module. This allows for bias while performing measurements from 100 MHz to the maximum frequency of the MA25400A module. Stand-alone, it is usable to 70 GHz.	Max Voltage: 50 VDC	Max Current: 500 mA	1 pA @ 1 VDC 50 pA @ 50 VDC
Tri-Axial Output SMUs	For applications requiring Source Measure Units (SMU) with tri-axial outputs, a tri-axial (male) to SMC (male) cable is available, with the inner-shield isolated from ground at the bias tee SMC end, to float at the SMU guard potential. Check the accessories list for ordering information on page 35 .			

Broadband Measurement Examples

The following figures are measurement examples of the ME7838G Broadband system performance. They do not represent specified performance, but serve to indicate common trends with frequency or power of several parameters of interest.

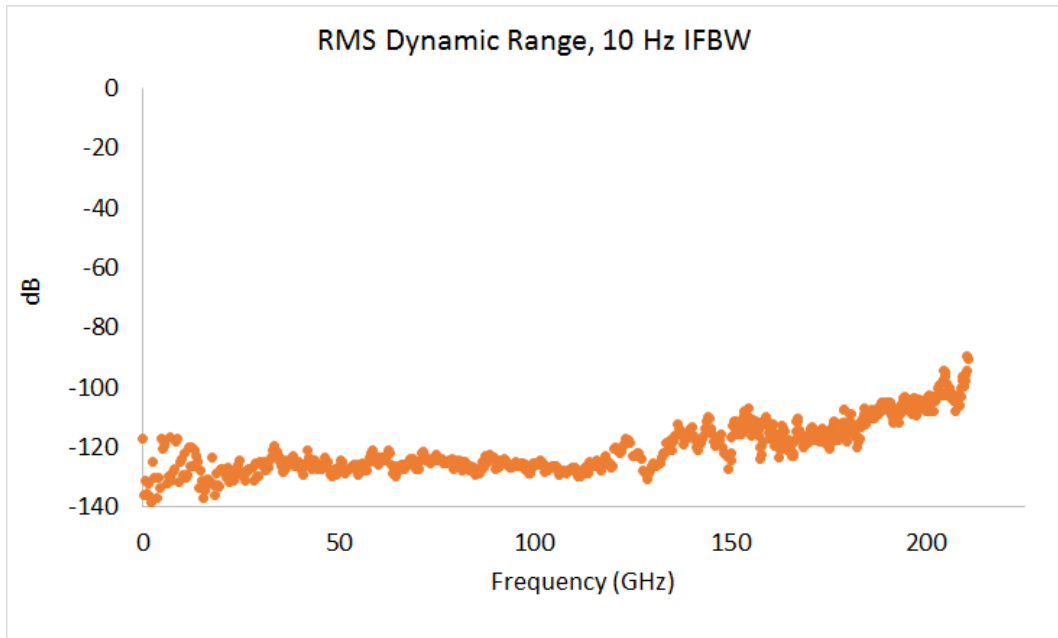

Example dynamic range of the ME7838G system at the flange interface connector from 70 kHz-220 GHz in a 10 Hz IF bandwidth. RMS computation.

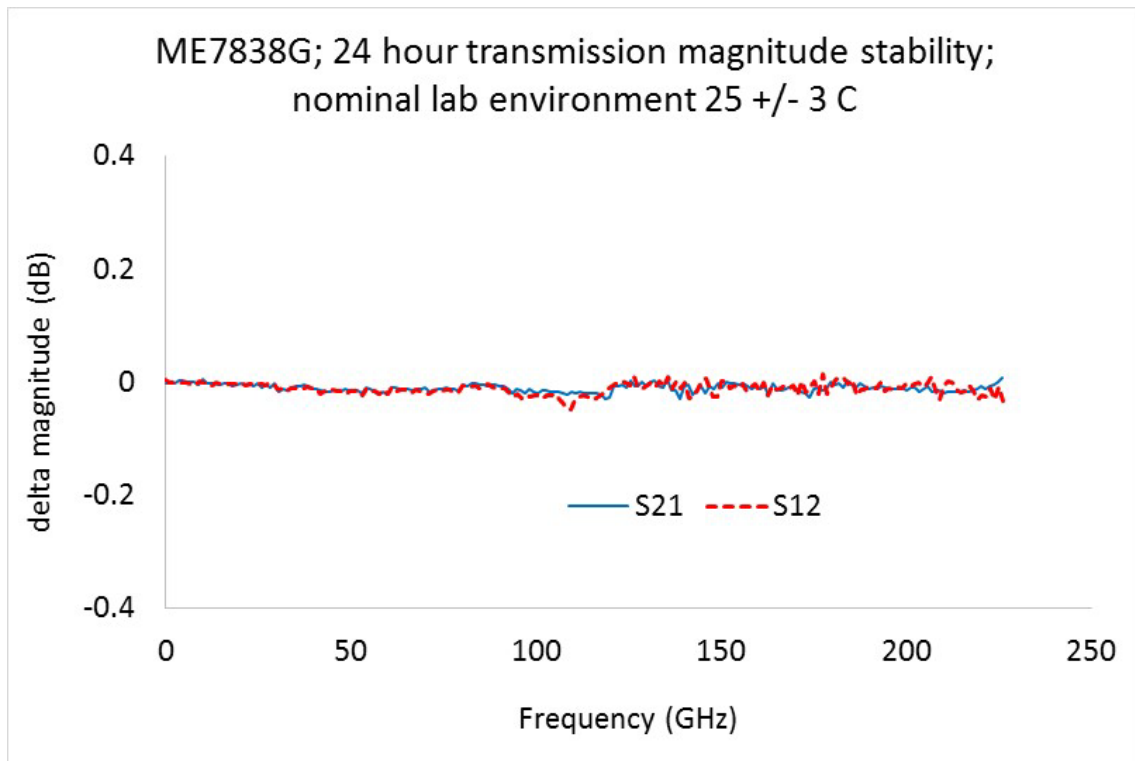

Example 24 Hour Transmission Magnitude Stability

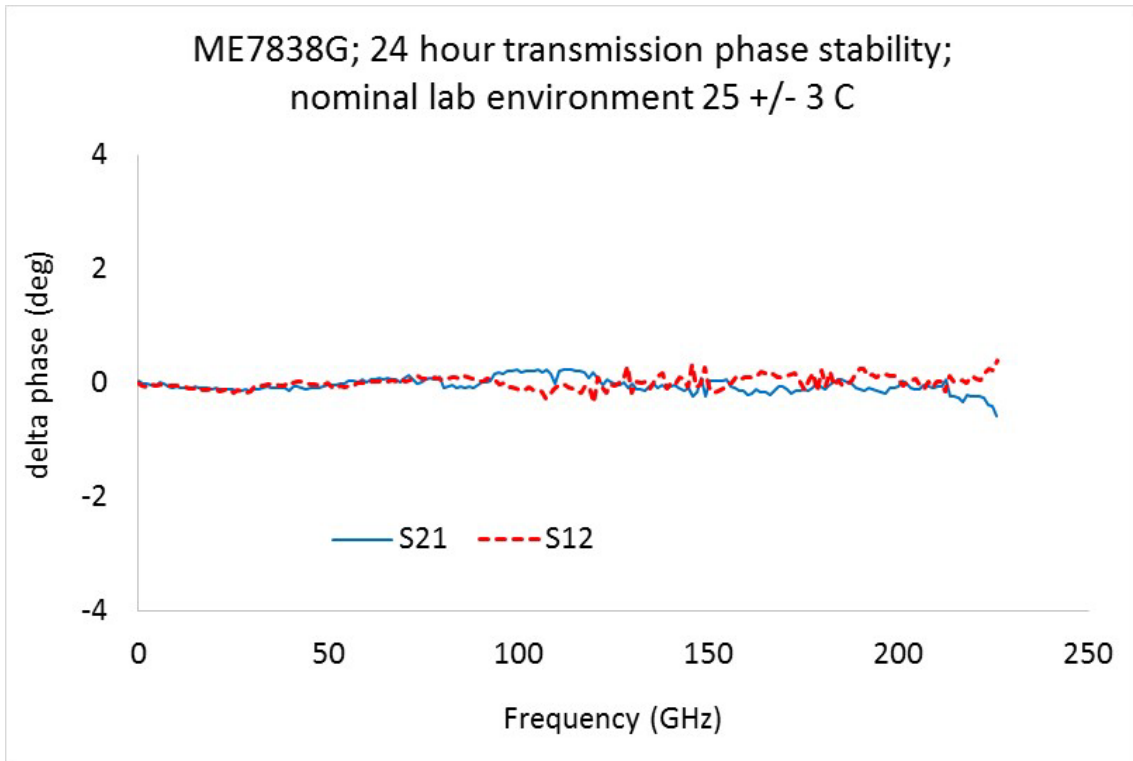

Example 24 Hour Transmission Phase Stability

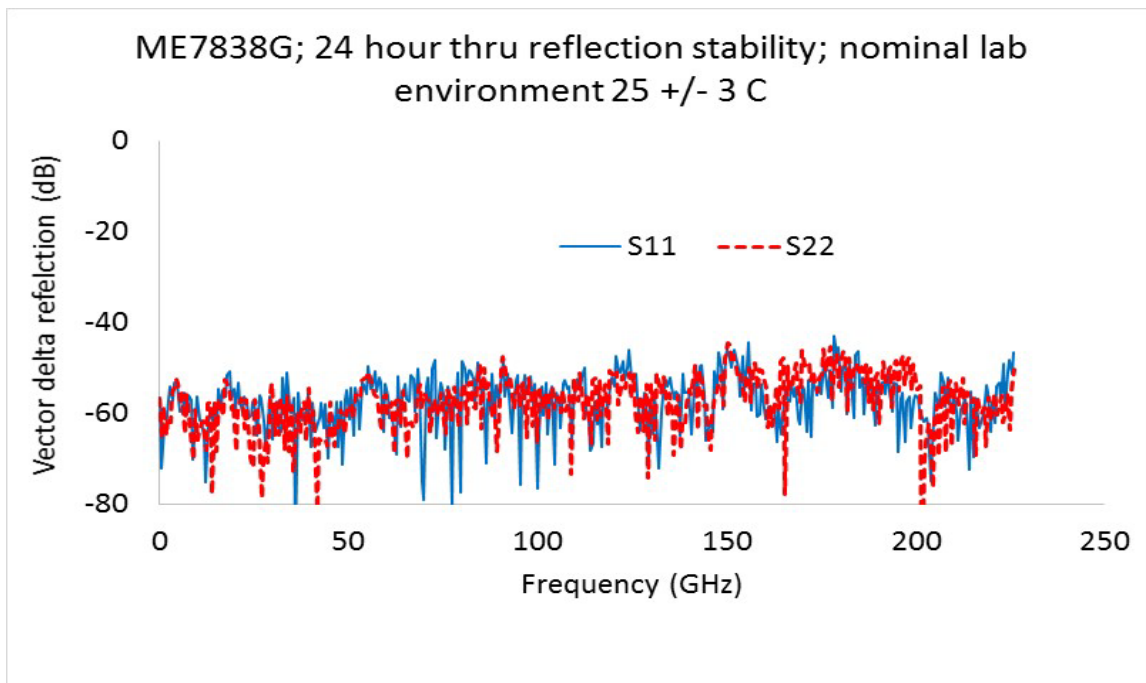

Example 24 Hour Thru Line Match Vector-delta Stability

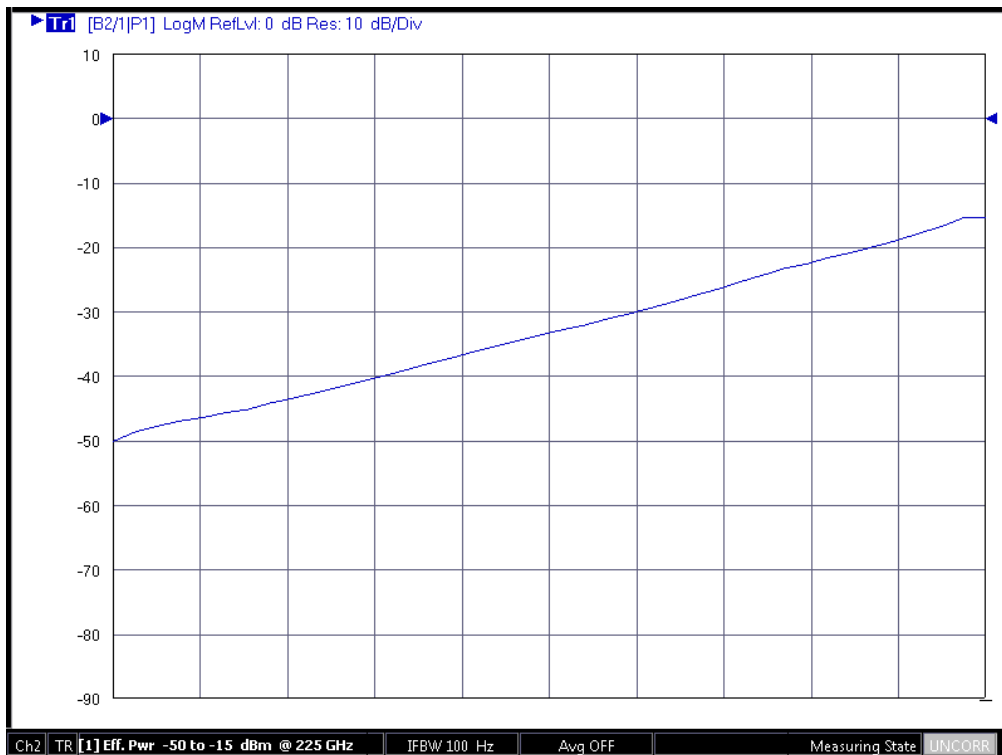

Example power sweep range at 225 GHz.
By using the detection and power control inside the MS25400A millimeter-wave module, improved accuracy, linearity and range are possible.

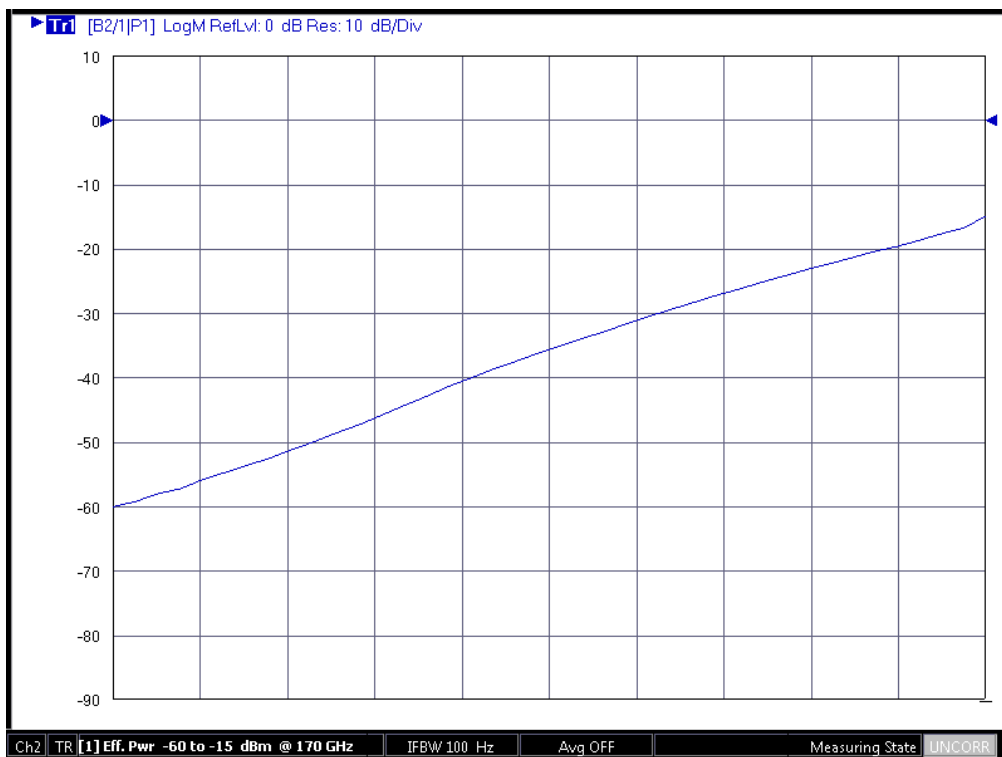

Example power sweep range at 170 GHz.

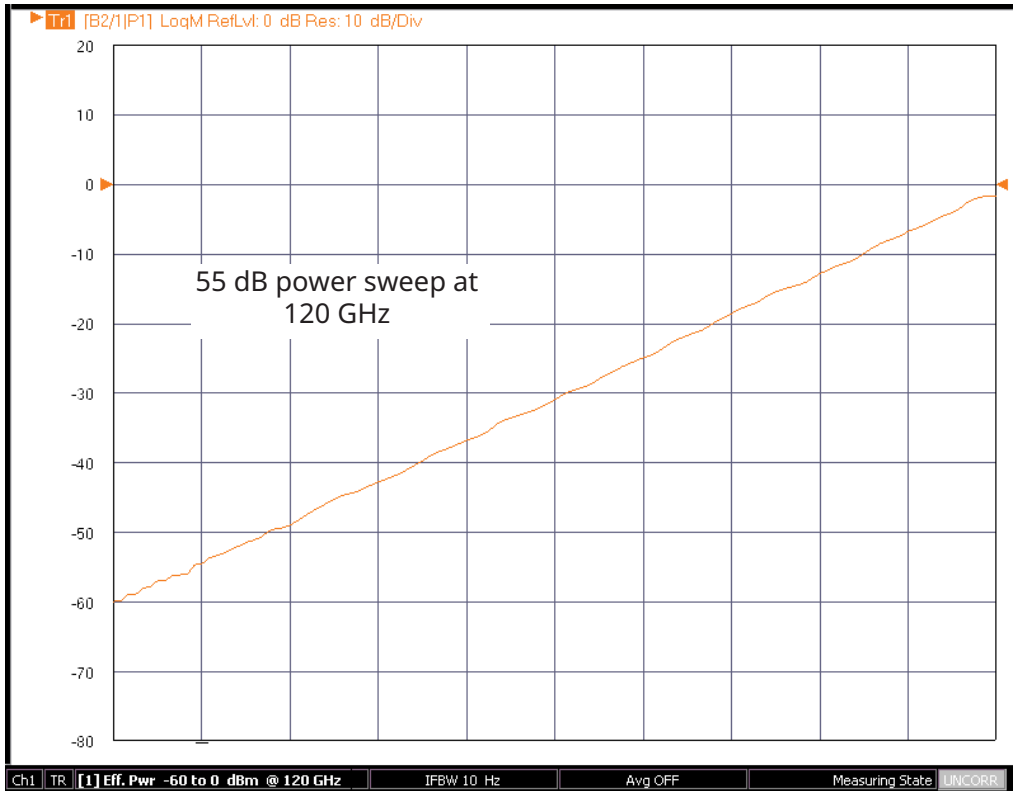

Power sweep range at 120 GHz demonstrating greater than 55 dB of control.

Specifications for Waveguide Band Configuration

ME7838G Millimeter-Wave VNA, Waveguide Bands

Three configurations are available for waveguide band operation above 145 GHz when using the ME7838G system.

- First, the MA25400A Broadband Millimeter-Wave module can be adapted to waveguide measurements using an available WR5 adapter. Lower band coaxial-to-waveguide adapters can be used in conjunction with the native 0.8 mm and 1 mm coaxial adapters for the MA25400A to cover lower waveguide band measurements.
- Second, the Anritsu 3744A-EE or 3744A-EW millimeter-wave module can be used. These version modules operate in the extended E and W waveguide bands and are operational using the MS4644B or MS4647B VectorStar (with Options 8x and 7) and the 3739C broadband/millimeter-wave test set.
- The third configuration option is to use external millimeter-wave modules with any model VectorStar (with Options 8x and 7) and the 3739C test set. For millimeter bands either the OML or VDI modules may be used.

Typical uncertainty curves and residual values are below for the first case where WR5 adapters are used on the MA25400A modules. These results were obtained using an SSLT calibration with an OML WR05 calibration kit. Other calibration kits with similar dimensional tolerances can perform similarly. Standard waveguide screw torque levels (6 cN-m) were used.

Frequency Range	Directivity and Load Match	Source Match	Reflection Tracking	Transmission Tracking
140-160 GHz	30	26	0.1	0.1
> 160-200 GHz	33	28	0.15	0.15
> 200-220 GHz	30	26	0.2	0.2

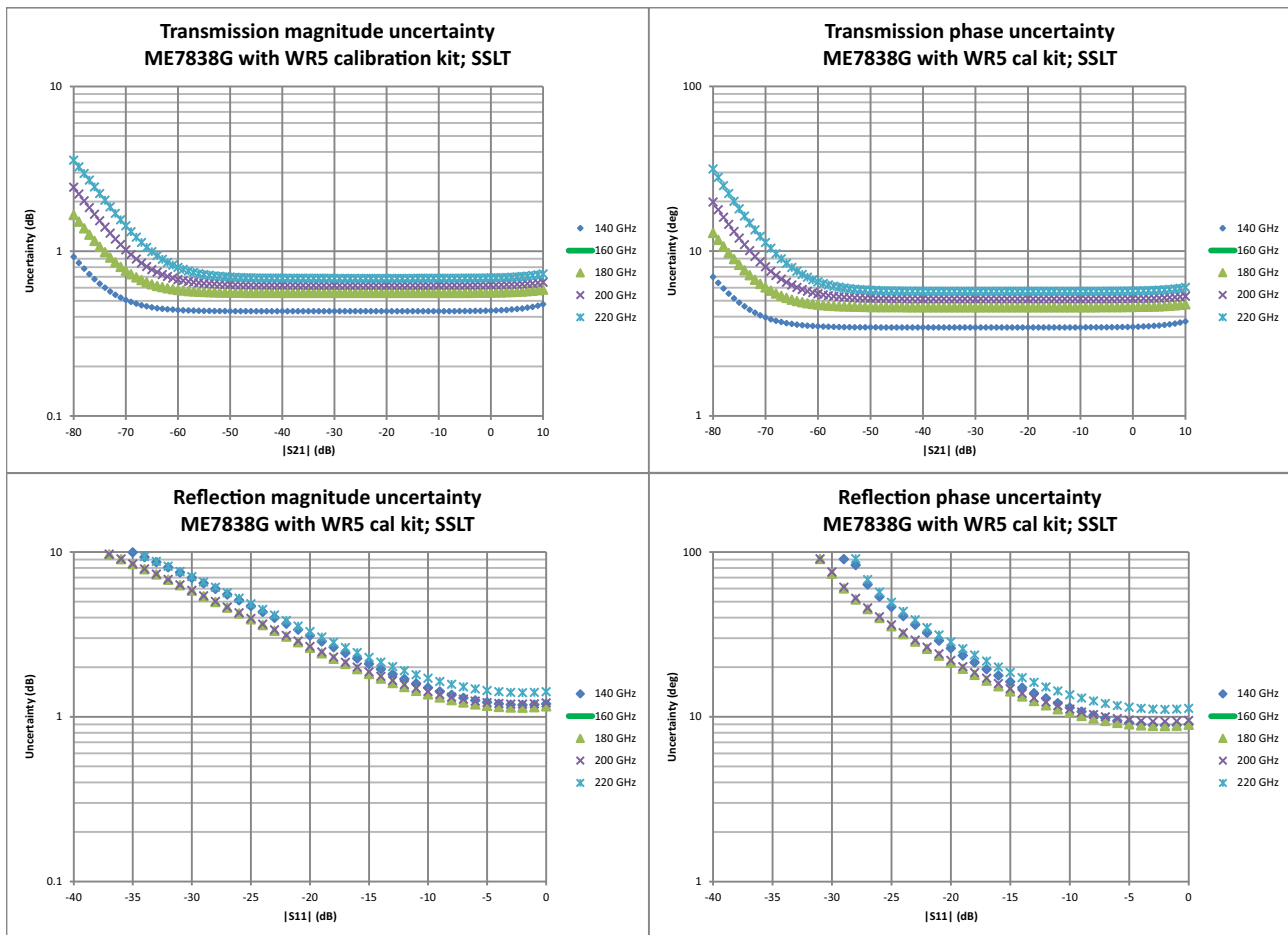

ME7838G with Option 41 and 3744A-Rx mm-Wave Noise Figure Measurements

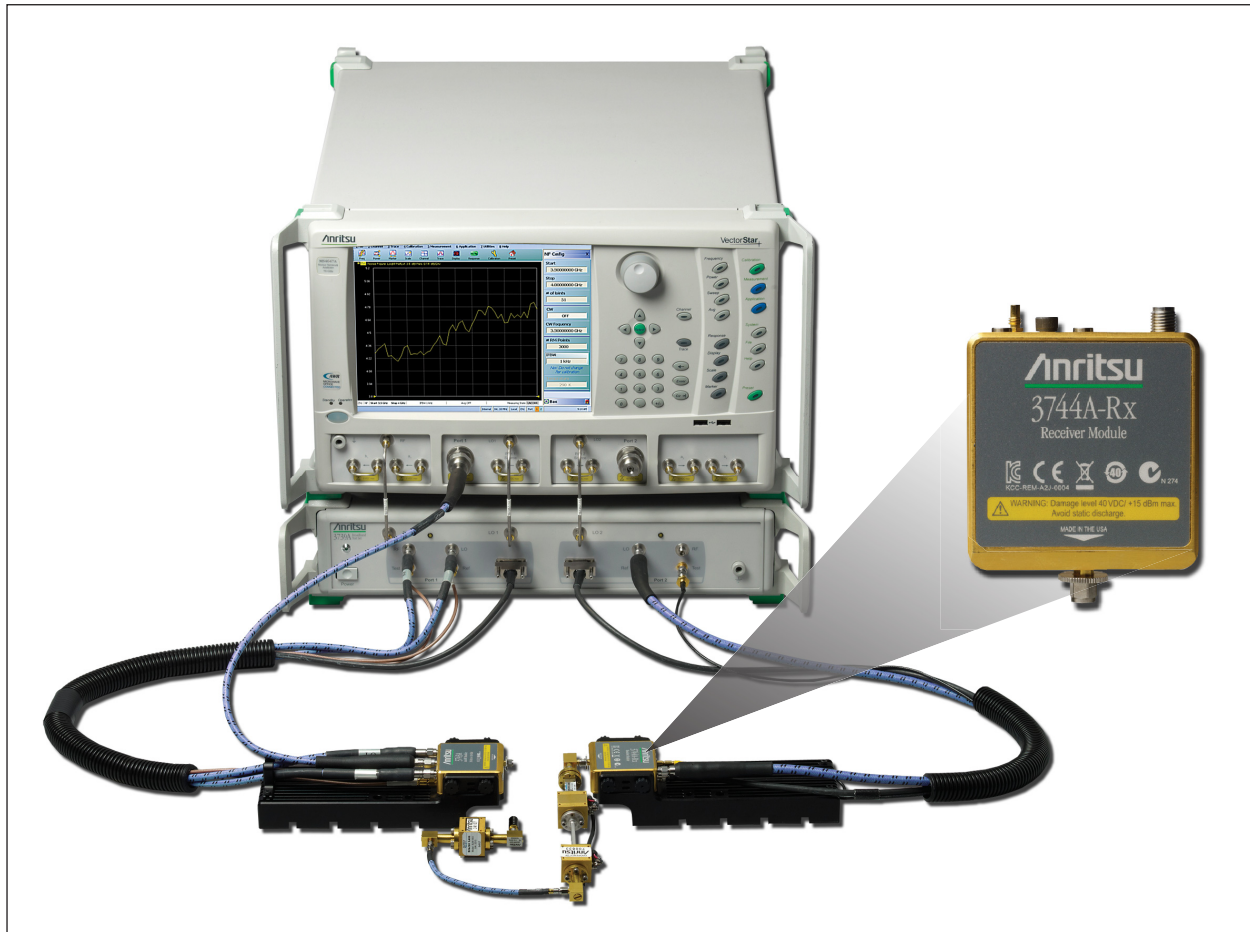

ME7838G with 3744A-Rx Receiver Module

The 3744A-Rx receiver module can be used with Option 41, Noise Figure, and the ME7838G mm-Wave or broadband system to perform mm-Wave noise figure measurements from 30 GHz to 125 GHz. The receiver bypasses the internal couplers (see block diagram), maximizing the noise figure of the receiver for optimum noise figure measurement accuracy. The receiver is derived from the 3743A mm-Wave module and utilizes the same nonlinear transmission line technology for optimum mm-Wave performance. Using the advantages of the 3743A mm-Wave module system architecture provides a unique solution to mm-Wave noise figure measurements previously unavailable. Receiver modules with different bandwidth ranges are available. Consult the factory for more information.

Block Diagram – 3744A Receiver Module

The 3744A-Rx receiver module is optimized as a receiver-only mm-Wave module for applications such as mm-Wave antenna measurements and mm-Wave noise figure measurements. Elimination of the input coupler produces a mm-Wave receiver with excellent noise floor sensitivity and dynamic range. When coupled with a composite receiver, the receiver module provides a solution for mm-Wave noise figure measurements.

As with all cold source method noise figure measurements, the output of the DUT is first sent to an external composite receiver for pre-amplification. This ensures that the system noise figure is minimized for optimum measurement accuracy. The Anritsu Noise Figure Uncertainty Calculator (available on the website at www.anritsu.com) can be used to determine optimum preamplifier gain needed for the desired measurement uncertainty.

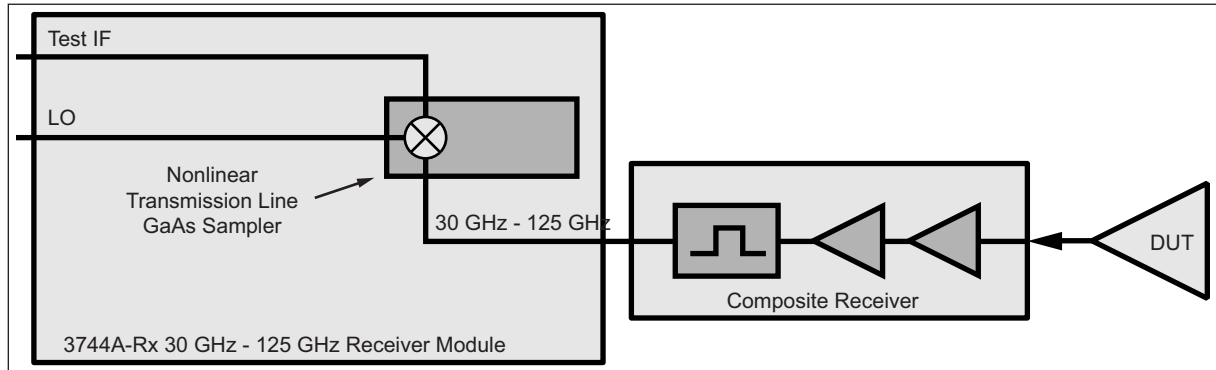

3744A-Rx Block Diagram configured for mm-Wave noise figure measurements

3744A-Rx Receiver Compression, Noise Floor

Receiver Compression Point is defined as the port power level beyond which the response may be compressed more than 0.2 dB relative to the normalization level. 10 Hz IF bandwidth is used to remove trace noise effects. All typical.

Noise Floor is relative to the receiver power calibration performed at -10 dBm. Typical.

Frequency (GHz)	Receiver Compression (dBm) ^a	Noise Floor (dBm) ^b
30 to 54	0	-124
> 54 to 60	0	-122
> 60 to 67	0	-117
> 67 to 80	0	-120
> 80 to 85	0	-123
> 85 to 90	0	-121
> 90 to 95	0	-121
> 95 to 105	0	-117
> 105 to 110	0	-122
> 110 to 120	-5	-120
> 120 to 125	-5	-117

a. At the 3744A-Rx test port.

b. Excludes localized spurious responses and crosstalk.

VectorStar ME7838G Waveguide Bands from 50 GHz to 1.1 THz

The VectorStar Millimeter-Wave system supports OML or VDI modules starting at 50 GHz. System performance is based on the specific mm-Wave module installed and appropriate cal kit. The mm-Wave modules need to provide IF levels of -15 dBm to -5 dBm when the RF drive is set to maximum in order to deliver specified dynamic range. Contact the vendor web site for additional information.

NOTE: The 3739C test set requires an IF power level in the -15 dBm to -5 dBm from 10 to 20 MHz. For existing mm-Wave modules, be sure to confirm output power to meet specified performance.

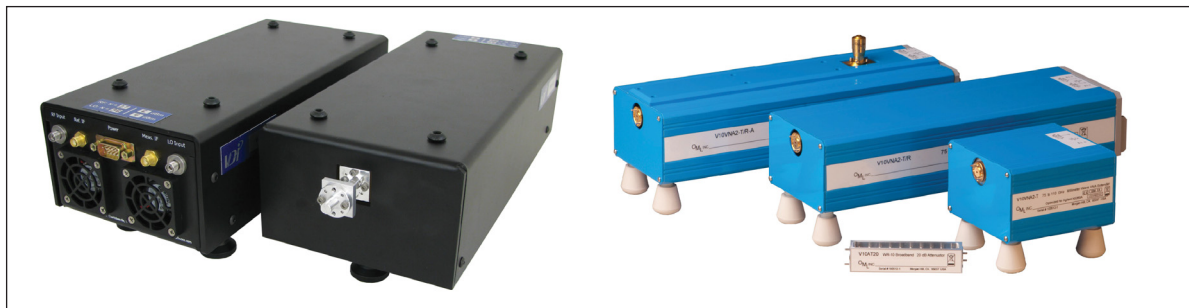

VDI and OML Millimeter-Wave Modules

Block Diagram - Millimeter-Wave VNA System

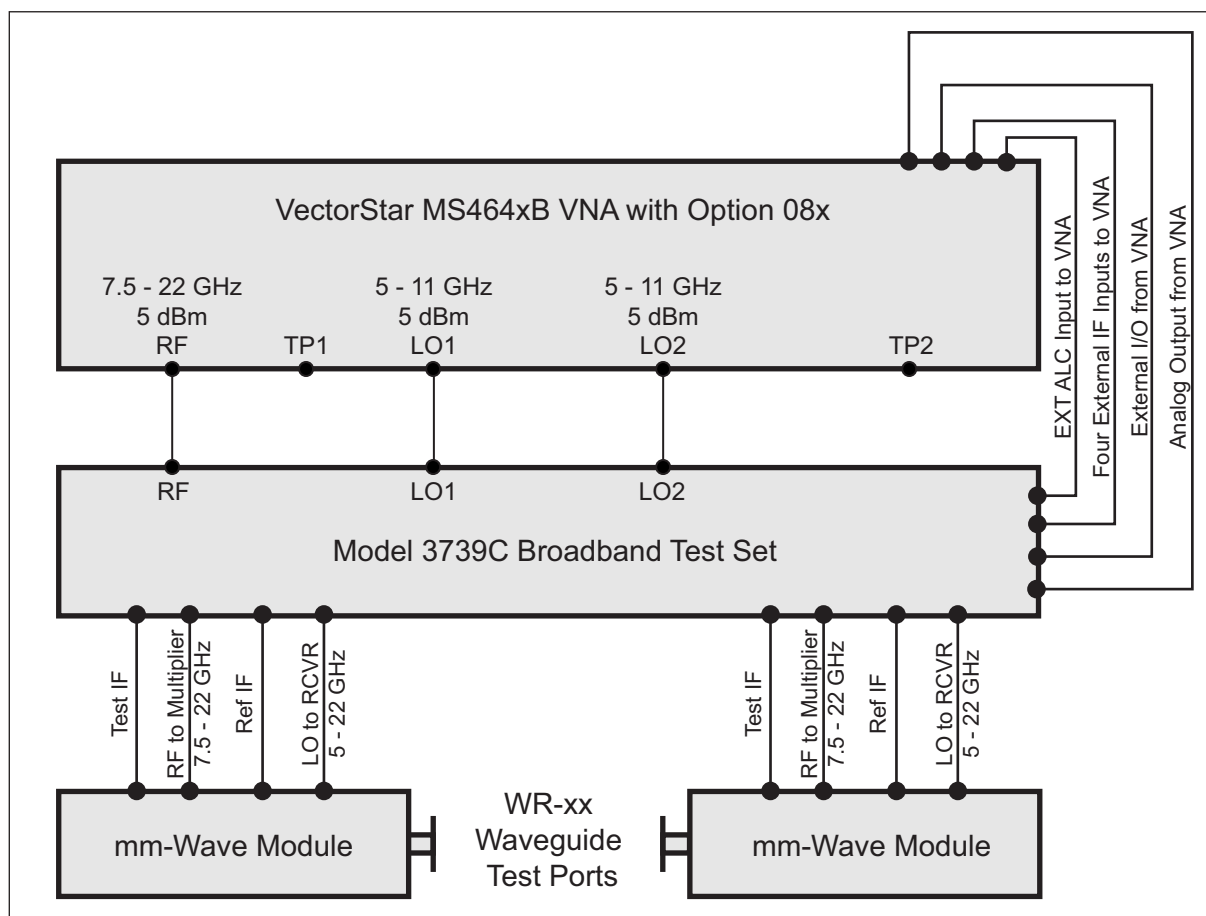

Millimeter-Wave Configuration Block Diagram

VectorStar ME7838G Millimeter-Wave System with VDI Modules

This section provides the specifications for the VectorStar MS4640B series microwave Vector Network Analyzers (VNAs) when configured with the Virginia Diodes, Inc. millimeter-wave (mm-Wave) frequency extension modules. The following frequency bands are supported:

Waveguide Band	WR15	WR10	WR8.0	WR6.5	WR5.1	WR4.3	WR3.4	WR2.8	WR2.2	WR1.5	WR1.0 ^a
Frequency (GHz)	50 to 75	75 to 110	90 to 140	110 to 170	140 to 220	170 to 260	220 to 330	260 to 400	330 to 500	500 to 750	750 to 1100

a. Contact Anritsu

System Configuration with VDI Modules

The VectorStar Millimeter-Wave system provides control of VDI modules for frequency extension coverage up to 1.1 THz*. MS4640B series VectorStar VNA may be configured for mm-Wave operation by adding the appropriate control option and test set. System requirements include:

- VectorStar VNA Model MS4642B, MS4644B, or MS4647B
(**Note:** For 1.1 THz operation, the 40 GHz MS4644B or higher model is required.)
- Options MS4640B Option 7, Receiver Offset
MS4640B Option 80, 81, 82, 83, 84, or 85 (86-89 acceptable for some modules)
- Test Set 3739C Test Set
- Cable SM6537 Interface Cable – Connection between VectorStar and the VDI mm-Wave module is provided with this interface cable.

Each VDI module is equipped with a dedicated external power supply and DC cable.

NOTE: The 3739C test set requires an IF power level in the -15 dBm to -5 dBm from 10 to 20 MHz. For existing mm-Wave modules, be sure to confirm output power to meet specified performance.

VDI Module Specifications

- Specifications: Dynamic range (DR) specifications are valid for any MS4640B VectorStar VNA with appropriate options. Directivity specifications are valid when using appropriate VDI calibration kits. These specification results assume a through measurement with two TxRx Heads. All extender heads include a precision Test Port. The specifications here are typical and subject to change.
- Stability: Measured for 1 hour after a 1 hour system warm-up, in a stable environment with ideal cables.
- Dynamic Range: The dynamic range (RBW 10 Hz) is measured by first connecting two TxRx heads together and normalizing the un-calibrated S21 and S12. The heads are then disconnected and terminated with a waveguide short. The rms of the measured S21 & S12 give the system dynamic range.
- Test Port Power: Test Port Power is typical. Reduced power is possible at band edges.

VDI Extenders-Summary of Specifications

Waveguide Band	WR15	WR12	WR10	WR8.0	WR6.5	WR5.1	WR4.3	WR3.4	WR2.8	WR2.2	WR1.5	WR1.0
Frequency Coverage (GHz)	50-75	60-90	75-110	90-140	110-170	140-220	170-260	220-330	260-400	330-500	500-750	750-1100
Dynamic Range BW = 10 Hz, (dB, Typical)	120	120	120	120	120	120	115	115	100	100	100	60
Dynamic Range BW = 10 Hz, (dB, minimum)	100	100	100	100	100	100	100	100	80	80	80	40
Magnitude Stability (± dB)	0.15	0.15	0.15	0.15	0.25	0.25	0.3	0.3	0.5	0.5	0.8	1
Phase Stability (± deg.)	2	2	2	2	4	4	6	6	8	8	10	15
Test Port Power (dBm Typical, Standard/High power)	6/13	6/10	6/10	0	0	-6	-6	-9	-16	-17	-25	-35
Test Port Input Limit ^a (dBm, Saturation/Damage)	16/20	16/20	16/20	16/20	9/20	9/20	-3/13	-4/13	-10/13	-10/13	-19/13	-20/13
Directivity (dB)	30	30	30	30	30	30	30	30	30	30	30	30
Typical Dimension (L x W x H, in)	11x5x3	11x5x3	11x5x3	11x5x3	11x5x3	11x5x3	11x5x3	11x5x3	11x5x3	11x5x3	11x5x3	8x5x3

a. Test Port Input Limits are shown for standard test port power models only.

VDI Module Head Configurations

- TxRx Transmitter with two receivers (reference and measurement), and two couplers. Two TxRx heads are required for full two-port measurements.
- TxRef Transmitter with reference receiver and one coupler.
- Rx Measurement receiver.
- Tx Transmitter.

VDI Module Options

- Micrometer-Drive Variable Attenuator A 0 dB to 30 dB micrometer-drive variable attenuator option is available on TxRx and Tx modules up through WR1.5. If ordered, "-Attn" is added as an option suffix to the module model number. The attenuators reduce TPP and DR by as much as 5dB in the WR3.4 and higher frequency bands and add approximately 2 in to the enclosure.
- Increased Test Port Power Options exist for increasing test port power in some full bands or in partial bands. Consult factory for more information.
- Non-Standard Frequency Bands Non-standard frequency bands or other specific needs are possible. Consult factory for more information.
- Custom Configuration Anritsu/VDI will work with customers to reconfigure any extender to meet specific needs.

ME7838G Measurement Examples Using VDI Millimeter-Wave Modules

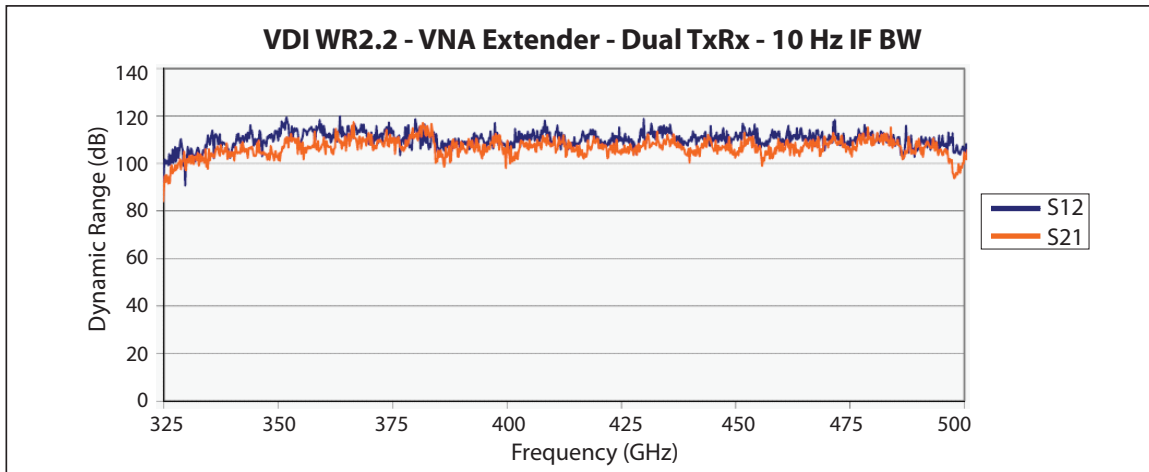

Dynamic Range Plot of VDI WR2.2 Module - 10 Hz IFBW

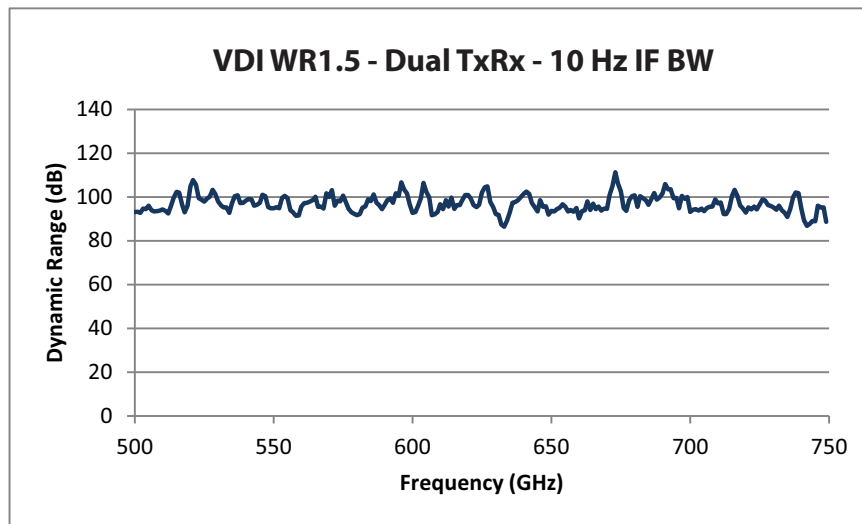

Dynamic Range Plot of VDI WR1.5 Dual TxRx - 10 Hz IFBW

ME7838G 400 GHz Power Sweep with VDI WR2.2 TxRx Module

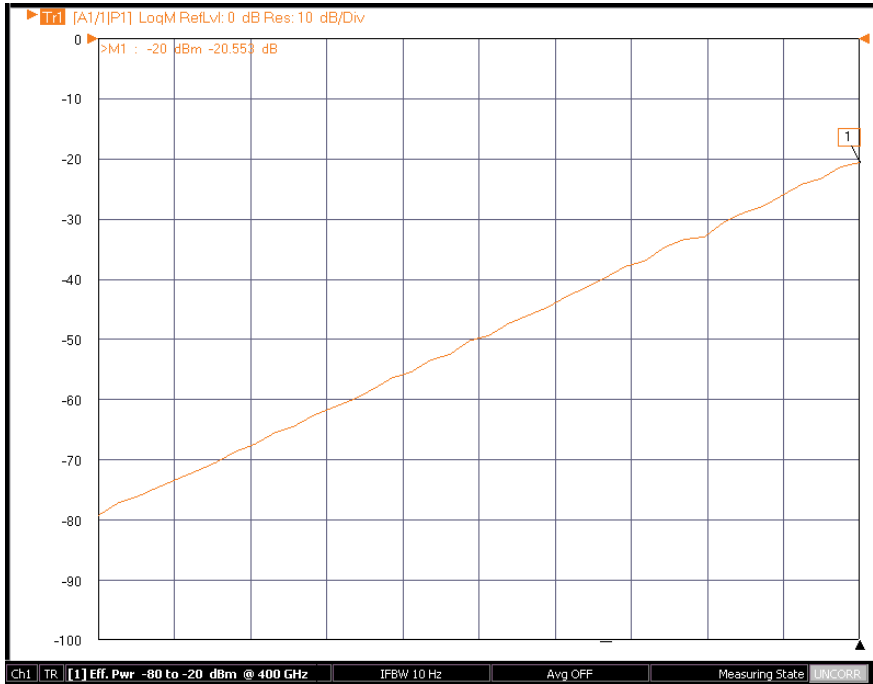

Real time power sweep of VDI WR2.2 module using system power level control and no mechanical attenuators.

VectorStar ME7838G Millimeter-Wave System with OML Modules

This section provides specifications for the VectorStar MS4640B series microwave Vector Network Analyzers (VNAs) when configured with the OML millimeter-wave frequency extension modules.

Description	Each OML module must be equipped with a dedicated external power supply and DC cable. Connection between the VectorStar and the OML mm-Wave module is provided with the supplied interface cable.
System Configuration	The VectorStar Millimeter-Wave system provides control of OML modules for frequency extension coverage up to 325 GHz. The MS4640B series VectorStar VNA may be configured for mm-Wave operation by adding the appropriate control option and test set.
System requirements	MS4642B, MS4644B, or MS4647B Model VectorStar VNA MS4640B Option 7, Receiver Offset MS4640B Option 80, 81, 82, or 83 SM6537 Interface Cable 3739C Test Set
Specifications	Dynamic range specifications are valid for any MS4640B VectorStar VNA with appropriate options. Directivity specifications are valid when using appropriate OML calibration kits.

OML Millimeter-Wave Extenders Summary Specifications

OML "T/R" Models ^a	Units	Measurement	V15VNA2-T/R	V12VNA2-T/R	V10VNA2-T/R	V08VNA2-T/R	V06VNA2-T/R	V05VNA2-T/R	V03VNA2-T/R
Output Interface ^b Operating Frequency	GHz	-	WR-15 50 – 75	WR-12 60 – 90	WR-10 75 – 110	WR-08 90 – 140	WR-06 110 – 170	WR-05 140 – 220	WR-03 220 – 325
Test Port Output Power ^c	dBm	Minimum Typical	+5 +8	+2 +5	+3 +5	-8 -4	-15 -10	-18 -13	-23
Test Port Input Power at 0.1 dB Compression ^d	dBm	Typical	+8	+8	+6	+4	-5	-5	-5
Test Port Match ^e	dB	Typical	> 17	> 17	> 17	> 17	> 15	> 15	> 9
Residual Source and Load Match	dB	Typical	> 35	> 35	> 35	> 35	> 35	> 35	> 33
Test Dynamic Range ^e	dB	Minimum Typical	92 > 105	92 > 105	95 > 110	90 > 105	80 > 95	80 > 95	60 > 75
Reflection and Transmission Tracking ^f	dB Deg	Magnitude Phase	±0.2 ±2	±0.2 ±2	±0.2 ±2	±0.3 ±3	±0.4 ±5	±0.4 ±6	±0.4 ±8
Coupler Directivity ^c	dB	Typical	> 35	> 35	> 35	> 33	> 30	> 30	> 30
Size ^g	in	(L x W x H)	13.0 x 4.3 x 2.7						

- a. Specifications are typical and subject to change without notice.
- b. Test Port Flange Configuration is compatible with MIL-DTL-3922/67D (UG 387/U-M).
- c. As there are no internationally recognized power standards above 110 GHz, any power data supplied above 110 GHz is traceable only to OML's calorimeter.
- d. Not Tested.
- e. Measured at 10 Hz IF bandwidth.
- f. At +25 °C. Measured for 1 hr after 1 hr warm-up. Based on "perfect" RF and LO test cables not moved after warm-up and calibration. Not tested.
- g. Height excludes the adjustable rubber feet; length and depth dimensions exclude the output waveguide length.

Standard Capabilities for All Configurations

For standard capabilities of the VectorStar VNAs, please see the **VectorStar MS4640B Series VNA Technical Data Sheet and Configuration Guide – 11410-00611**, available at www.anritsu.com.

Mechanical and Environmental

MS4640B Vector Network Analyzer

Dimensions without rack mount option.	
Height	267 mm body (6u) 286 mm between feet outer edges
Width	426 mm body 457 mm between feet outer edges 487 mm between front panel handles outer edges
Depth	502 mm body 591 mm between handle and foot outer edges
Weight	< 28 kg (< 62 lbs) Typical weight for a fully-loaded MS4647B VNA

3739C Broadband/Millimeter-Wave Test Set

Dimensions without rack mount option.	
Height	89 mm body (2u) 108 mm between feet outer edges
Width	426 mm body 457 mm between feet outer edges 487 mm between front panel handles outer edges
Depth	502 mm body 591 mm between handle and foot outer edges
Weight	5.75 kg (12.7 lbs)

MA25400A Millimeter-Wave Module

Height	32.5 mm
Width	54 mm
Depth	83 mm
Weight	0.27 kg (0.6 lbs)

Environmental – Operating

Conforms to MIL-PRF-28800F (Class 3)	
Temperature Range	0 °C to +50 °C without error codes* * Except for 'unleveled' error messages that may occur at the extreme edges of the temperature range above.
Relative Humidity	5 % to 95 % at +30 °C, Non-condensing
Altitude	4,600 m (15,000 ft)

Environmental – Non-Operating

Temperature Range	-40 °C to +71 °C
Relative Humidity	0 % to 90 % at +30 °C, Non-condensing
Altitude	4,600 m (15,000 ft)

Regulatory Compliance

European Union	EMC 2014/30/EU, EN 61326:2013, CISPR 11/EN 55011, IEC/EN 61000-4-2/3/4/5/6/8/11 Low Voltage Directive 2014/35/EU Safety EN 61010-1:2010 RoHS Directive 2011/65/EU applies to instruments with CE marking placed on the market after July 22, 2017.
Australia and New Zealand	RCM AS/NZS 4417:2012
South Korea	KCC-REM-A21-0004

Warranty

The ME7838G Series VNAs and related accessories offer a 3 year warranty from the date of shipment (excluding OML and VDI modules, and MPI probes). Please contact your local service center for additional warranty coverage.

Calibration and Correction Capabilities

Calibration Methods	<p>Short-Open-Load-Through (SOLT) with Fixed or Sliding Load and supporting .s1p-defined cal kits</p> <p>Offset-Short-Offset-Short-Load-Through (SSLT) with Fixed or Sliding Load</p> <p>Triple-Offset-Short-Through (SSST) and overdetermined offset short (mSSST)</p> <p>Short-Open-Load-Reciprocal (SOLR) or Unknown Through Method (SSLR, SSSR)</p> <p>Line-Reflect-Line (LRL) / Line-Reflect-Match (LRM) – (up to 5 bands supported for multi-line configurations)</p> <p>Thru-Reflect-Line (TRL) - (up to 5 bands supported)</p> <p>Advanced-LRM (A-LRM™) for improved on-wafer calibrations</p> <p>Multiline TRL (mTRL)</p> <p>Hybrid calcs (allows combination of sub-cals of different type or media)</p> <p>AutoCal</p> <p>Thru Update available</p> <p>Secondary match correction available for improved low insertion loss measurements</p>
Correction Models	<p>2-Port (Forward, Reverse, or both directions)</p> <p>1-Port (S_{11}, S_{22}, or both)</p> <p>Transmission Frequency Response (Forward, Reverse, or both directions)</p> <p>Reflection Frequency Response (S_{11}, S_{22}, or both)</p>
Merged Calibration	<p>Merge multiple calibration methods over bands of frequency points.</p> <p>Note that merge does not need to be used for broadband coaxial (SOLT/R-SSST/R) 1 mm or 0.8 mm calibrations using Anritsu calibration kits. These can be done as one unified calibration.</p>
Coefficients for Calibration Standards	<p>Use the Anritsu calibration kit USB Memory Device to load kit coefficients and characterization files.</p> <p>Enter manual coefficients into user-defined locations.</p> <p>Use complex load models.</p>
Reference Impedance	<p>Modify the reference impedance from 50 Ω to any impedance greater than 0 Ω.</p>
Interpolation	<p>Allows interpolation between calibration frequency points. Accuracy will be reduced at non-calibration frequencies and that degradation is dependent on the frequency step size in the initial calibration and the electrical length of the user’s setup.</p>
Adapter Removal Calibration	<p>Characterizes and “removes” an adapter that is used during calibration that will not be used for subsequent device measurements; for accurate measurement of non-insertable devices.</p>
Dispersion Compensation	<p>Selectable as Coaxial, other non-dispersive (e.g., for coplanar waveguide), Waveguide, or Microstrip.</p>
Power	<p>Power Meter Correction Different power meter calibrations are available to enhance power accuracy at the desired reference plane. The source power will match the target calibration power, as read by the power meter, to within ~ 0.1 dB for short periods of time (determined by thermal drift of the system and the power meter). The absolute accuracy of the calibrated power will be dependent on the power meter and sensor used.</p> <p>Flat Power Calibrations A flat power calibration (when in frequency sweep mode) is available at a user-selectable power level, if it is within the power adjustment range of the internal source. The flat power correction is applied to other power levels directly as an offset. Multiple power meters/sensors may be needed depending on the frequency range. An adapter may be required to the 1mm module test port.</p> <p>Linear Power Calibrations A linear power calibration is performed over a range of power levels for use in power sweep mode and is performed at a specified frequency or frequency range (for multifrequency gain compression).</p> <p>External Power Meter Both calibrations are performed using an external power meter (Anritsu ML2438A, ML248xB, ML249xA, Agilent 437B (or equivalent), Rhode and Schwarz NRP2 meter with a broadband 110 GHz sensor, or Elva DPM power meter) over the Dedicated GPIB port, or a USB power sensor (Anritsu MA24106A, MA24108A, MA24118A, MA24126A, MA24208A, MA24218A, MA24330A, MA24340A, MA24350A, MA24507A) connected to a USB port.</p> <p>Note: Usage of the MA24500A series sensor requires a dual USB Type A male to single USB Type A female cable to supply needed current draw.</p>
Embedding/De-embedding	<p>The MS4640B is equipped with an Embedding/De-embedding system.</p> <p>De-embedding De-embedding is generally used for removal of test fixture contributions, modeled networks and other networks described by S-parameters (s2p files) from measurements.</p> <p>Embedding Similarly, the Embedding function can be used to simulate matching circuits for optimizing amplifier designs or simply adding effects of a known structure to a measurement.</p> <p>Multiple Networks Multiple networks can be embedded/de-embedded and changing the port and network orientations is handled easily.</p> <p>Extraction Utility An extraction utility is part of this package that allows the easier computation of de-embedding files based on some additional calibration steps and measurements.</p>
Impedance Conversion	<p>Allows entry of different impedances (complex values) for different ports.</p>

Mechanical Calibration/Verification Kits

W1 (1 mm) Calibration/Verification Kit, 3656B

Provides 12-term SOLT or Triple Offset Short calibrations, for W1 (1 mm) devices, and two verification standards. The -3 options adds .s1p standards definition files for reduced calibration-related uncertainties.



3656B W1 1 mm Calibration/Verification Kit providing 12-Term SOLT or SSST calibrations and two verification standards.

3656B Cal Kit Contains:	Additional Information (Typical)	Quantity	Part Number
Offset Short W1 (male)	Offset: 2.020 mm	1	23W50-1
Offset Short W1 (male)	Offset: 2.650 mm	1	23W50-2
Offset Short W1 (male)	Offset: 3.180 mm	1	23W50-5
Offset Short W1 (female)	Offset: 2.020 mm	1	23WF50-1
Offset Short W1 (female)	Offset: 2.650 mm	1	23WF50-2
Offset Short W1 (female)	Offset: 3.180 mm	1	23WF50-5
Open W1 (male)	Offset: 1.510 mm	1	24W50
Open W1 (female)	Offset: 1.930 mm	1	24WF50
Fixed Termination W1 (male)		1	28W50
Fixed Termination W1 (female)		1	28WF50
Adapter, W1 (male) to Fixed SC ^a Connector		1	33WSC50
Adapter, W1 (female) to Fixed SC ^a Connector		1	33WFSC50
Interchangeable Slider for SC ^a Connector (male)		1	-
Interchangeable Slider for SC ^a Connector (female)		1	-
Locking Keys for SC ^a Connectors		2	-
Pin Exchange Tool for SC ^a Connectors	Contains 1 male pin	1	01-402
Adapter, W1 (male) to W1 (female)		1	33WWF50
Adapter, W1 (male) to W1 (male)		1	33WW50
Adapter, W1 (female) to W1 (female)		1	33WFWF50
Stepped Impedance ThruLine, W1 (male - female)	Verification Device	1	18WWF50-1B
50 Ohm matched ThruLine, W1 (male - female)	Verification Device	1	18WWF50-1
Torque Wrench	6 mm, 5.4 N-cm (4 lbf-in)	1	01-504
Open-ended Wrench	6 mm / 7 mm	1	01-505
Coefficients for standards	On USB Memory Device and 3.5 in Floppy Disk	1	-

a. SC Connectors are a solution for accurate calibrations for non-insertable 1 mm devices. Users can change the gender of the SC connector using the provided tool, pin, sliders, and locking keys to ensure the best pin-depth, thus calibrations are valid after changing the gender of the adapter.

0.8 mm Calibration/Verification Kit, 3659

Provides 12-term SOLT or Triple Offset Short calibrations, for 0.8 mm devices, and two verification standards.



3659 0.8 mm Calibration/Verification Kit providing 12-Term SOLT or SSST calibrations and two verification standards.

3659 Cal Kit Contains:	Additional Information (Typical)	Quantity	Part Number
0.8 mm Calibration / Verification Kit			3659
Offset Short 0.8 mm (male)	Offset: 1.200 mm	1	23.850-1
Offset Short 0.8 mm (male)	Offset: 1.630 mm	1	23.850-2
Offset Short 0.8 mm (male)	Offset: 2.060 mm	1	23.850-3
Offset Short 0.8 mm (female)	Offset: 1.200mm	1	23.8F50-1
Offset Short 0.8 mm (female)	Offset: 1.630 mm	1	23.8F50-2
Offset Short 0.8 mm (female)	Offset: 2.060 mm	1	23.8F50-3
Open 0.8 mm (male)	Offset: 1.200 mm	1	24.850
Open 0.8 mm (female)	Offset: 1.200 mm	1	24.8F50
Fixed Termination 0.8 mm (male)		1	28.850
Fixed Termination 0.8 mm (female)		1	28.8F50
Adapter, 1.0 mm (male) to 0.8 mm (male) Connector		1	33W.850
Adapter, 1.0 mm (male) to 0.8 mm (female) Connector		1	33W.8F50
Adapter, 1.0 mm (female) to 0.8 mm (male) Connector		1	33WF.850
Adapter, 1.0 mm (female) to 0.8 mm (female) Connector		1	33WF.8F50
Adapter, 0.8 mm (male) to 0.8 mm (female)		1	33.8.8F50
Adapter, 0.8 mm (male) to 0.8 mm (male)		1	33.8.850
Adapter, 0.8 mm (female) to 0.8 mm (female)		1	33.8F.8F50
Stepped Impedance ThruLine, 0.8 mm (male - female)	Verification Device	1	18.8.8F50-1B
50 Ohm matched ThruLine, 0.8 mm (male - female)	Verification Device	1	18.8.8F50-1
Torque Wrench	6 mm, 5.4 N-cm (4 lbf-in)	1	01-524
Open-ended Wrench	6 mm / 7 mm	1	01-525
Coefficients for standards	On USB Memory Device	1	-

Test Port Cables

Test Port Cables, Flexible, High Performance

Description	Frequency Range	Impedance	Length (cm)	Insertion Loss (dB)	Return Loss (dB)	Part Number
1.0 mm (male) 1.0 mm (female)	DC to 110 GHz (125 GHz)	50 Ω	10	1.74	≥ 14	3671W1-50-1
13			2.23	≥ 14	3671W1-50-2	
16			2.74	≥ 14	3671W1-50-3	
0.8 mm (male) 0.8 mm (female)	DC to 145 GHz	50 Ω	10	2	≥ 12	3670.850-1
0.8 mm (male) 0.8 mm (female)	DC to 145 GHz	50 Ω	16	3.5	≥ 12	3670.850-2



3670.850-1, 3670.850-2, 0.8 mm Test Port Cables

Information on Using MA25400A-specific Adapters

The flange-based RF coaxial interface is a unique test port that enables simple direct connection to broadband RF probes. There are times when it is desirable to adapt to other media and the adapters listed below can help.

To do direct 1 mm coaxial S-parameter measurements: use the 33WG50 adapters. Additional 1 mm adapters are in the 3656 series calibration kit. Two of the 33WG50 adapters are included in the ME7838G system accessory kit.

To do direct 0.8 mm coaxial S-parameter measurements and verifications: use the 33.8G50 adapters. Additional 0.8 mm adapters are in the 3659 calibration kit.

To do direct WR-5 waveguide S-parameter measurements and assurance tests: use the 35WR5G adapters.

To do simple, direct broadband measurements in the native interface: use the 33GG50 thru. One of these thrus is included in the ME7838G system accessory kit.

To do power calibrations: At a minimum, the 33WG50 and 35WR5G adapters are needed to cover the full frequency range of the instrument (using 3-4 power meters). Power calibrations over subsets of the range may only need one adapter depending on the frequencies involved. Adapter loss can be de-embedded using the power calibration embedding/de-embedding tools and generic adapter .s2p files provided by Anritsu (or the individual adapters can be user-characterized directly for even greater accuracy). Please refer to the VectorStar Calibration and Measurement Guide (P/N: 10410-00318) for more information.

Description	Frequency Range	Insertion Loss (dB)	Return Loss (dB)	Part Number
Flange interface to 1 mm (male)	DC to 110 GHz (125 GHz)	< 1.0	> 15	33WG50
Flange interface to 0.8 mm (male)	DC to 145 GHz (150 GHz)	< 1.5	> 12	33.8G50
Flange interface to WR5 waveguide	140 to 220 GHz (226 GHz)	< 1.0	> 15	35WR5G
Flange interface 50 mm thru line (male male)	DC to 220 GHz (226 GHz)	< 3.0	> 12	33GG50

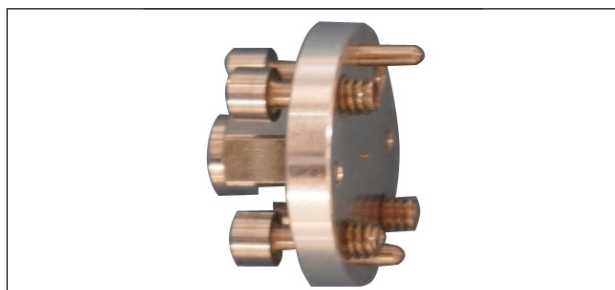

33WG50 W1 to MA25400A Flange Adapter

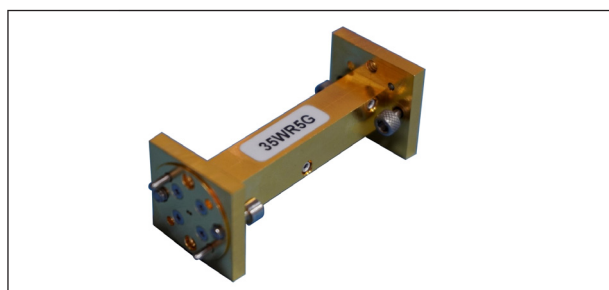

35WR5G WR5 Waveguide Adapter to MA25400A Flange Adapter

Precision Adapters, Attenuators, and Other Components

Anritsu offers a complete line of precision adapters and attenuators. For more information, please visit our web site at www.anritsu.com.



Ordering Information

The ME7838G Broadband/Millimeter-Wave VNA System provides single sweep coverage from 70 kHz to 220 GHz and consists of the following standard components and optional accessories described in the sections below:

ME7838G Broadband System, 70 kHz to 220 GHz

Action	Part Number and Description	Additional Information
Order the base VectorStar model with the listed options:	MS4647B, 70 kHz to 70 GHz VNA MS4640B-007, receiver offset MS4640B-070, 70 kHz frequency coverage 3739C, Broadband Test Set with 36 inch interface cables MA25400A, Millimeter-Wave Module, 2 each ME7838G-SS020, On-site system assembly and verification	
Include one of the following:	MS4647B-080, MS4647B with ME7838G system option MS4647B-081, MS4647B with ME7838G system option and Option 51 or 61 or 62	MS4647B-084 is ordered when Option 31 is included. MS4647B-085 is ordered when Option 31 is included.
Include the following:	806-209-R, 1.85 mm phase stable VNA RF cables, 36", M-F, 2 each	
Add options if desired:	Option 51, or 61, or 62: MS4647B-051 – External VNA Loops MS4647B-061 – Active Measurement Suite, 2 Attenuators MS4647B-062 – Active Measurement Suite, 4 Attenuators MS4640B-002 – for Time Domain MS4640B-021 – UFX, Universal Fixture Extraction MS464xB-031 – Dual Source Architecture MS4640B-035 – IF Digitizer MS4640B-041 – Noise Figure MS4640B-042 – PulseView™ MS4640B-043 – DifferentialView™	MS464xB-031 requires Option 84 or 85. For other available options, see “ME7838G Broadband/Millimeter-Wave System Options”
Accessories	MS4640B-001, MS4640B rack mount 3739C-001, 3739C rack mount	

ME7838G Waveguide-Band System to 110 GHz – 3744A-EE or 3744A-EW mm-Wave Modules

Configurator for ME7838G Millimeter-Wave System using 3744A-EE or 3744A-EW mm-Wave Modules:

Action	Part Number and Description	Additional Information
Choose and order one of the two base VectorStar models with options listed:	MS4644B VNA, 10 MHz to 40 GHz MS4640B-007 MS4644B-082 or -083 or -084 or -085 MS4647B VNA, 10 MHz to 70 GHz MS4640B-007 MS4647B-080 or -081 or -084 or -085	MS4644B-083 is ordered when Options 51, 61, or 62 are included. MS4644B-084 is ordered when Option 31 is included and Options 51, 61, or 62 are <i>excluded</i> . MS4644B-085 is ordered when Option 31 is included and Options 51, 61, or 62 are <i>included</i> . MS4647B-081 is ordered when Options 51, 61, or 62 are included MS4647B-084 is ordered when Option 31 is included and Options 51, 61, or 62 are <i>excluded</i> . MS4647B-085 is ordered when Option 31 is included and Options 51, 61, or 62 are <i>included</i> .
Order Test Set	3739C mm-Wave Test Set	
Choose and order Extended-E or Extended-W Band Modules:	3744A-EE, 56 GHz to 94 GHz Extended E Band module, 2 each 3744A-EW, 65 GHz to 110 GHz Extended W Band module, 2 each	
Add options if desired:	Option 51, or 61, or 62: MS464xB-051 – External VNA Loops MS464xB-061 – Active Measurement Suite, 2 Attenuators MS464xB-062 – Active Measurement Suite, 4 Attenuators MS4640B-070 – for 70 kHz operation in base VNA MS4640B-002 – for Time Domain MS464xB-031 – Dual Source Architecture MS4640B-035 – IF Digitizer MS4640B-041 – Noise Figure MS4640B-042 – PulseView™ MS4640B-043 – DifferentialView™ MS4640B-001, MS4640B Rack Mount 3739C-001, 3739C Rack Mount	MS464xB-031 requires Option 84 or 85. For other available options, see “ME7838G Broadband/Millimeter-Wave System Options”
Accessories	35WR12WF-EE – Precision Waveguide to Coax Adapter Kit, 56 GHz to 94 GHz, WR-12 to W1 (f) 35WR10WF-EW – Precision Waveguide to Coax Adapter Kit, 65 GHz to 110 GHz, WR-10 to W1 (f)	

ME7838G Waveguide-Band System – OML/VDI mm-Wave Modules

ME7838G Waveguide-band System using OML or VDI Millimeter-Wave modules:

Action	Part Number and Description	Additional Information
Choose and order one of the three base VectorStar models with options listed:	MS4642B VNA, 10 MHz to 20 GHz MS4640B-007 Receiver Offset MS4642B-061 or MS4642B-062 MS4642B-083 or -085	MS4642B-061 includes Active Device Measurements, with 2 Step Attenuators MS4642B-062 includes Active Device Measurements, with 4 Step Attenuators MS4642B-085 is ordered when Option 31 is included.
	MS4644B VNA, 10 MHz to 40 GHz MS4640B-007 Receiver Offset MS4644B-082 or -083 or -084 or -085	MS4644B-083 is ordered when Options 51, 61, or 62 are included. MS4644B-084 is ordered when Option 31 is included and Options 51, 61, or 62 are <i>excluded</i> . MS4644B-085 is ordered when Option 31 is included and Options 51, 61, or 62 are <i>included</i> .
	MS4647B VNA, 10 MHz to 70 GHz MS4640B-007 Receiver Offset MS4647B-080 or -081 or -084 or -085	MS4647B-081 is ordered when Options 51, 61, or 62 are included. MS4647B-084 is ordered when Option 31 is included and Options 51, 61, or 62 are <i>excluded</i> . MS4647B-085 is ordered when Option 31 is included and Options 51, 61, or 62 are <i>included</i> .
Order:	3739C mm-Wave Test Set SM6537 Interface Cables (2) for OML/VDI mm-Wave Modules	Does not include DC cable. DC supply is provided by mm-Wave module power supply.
Choose and order one of the two appropriate millimeter-wave module combinations:	2 each TxRx transmission and reflection millimeter-wave modules 1 each TxRx transmission and reflection module, and 1 each Tx transmission only module	Choose appropriate OML or VDI modules. Contact Anritsu Company for ordering information.
Add options if desired:	Option 51, or 61, or 62: MS464xB-051 – External VNA Loops MS464xB-061 – Active Measurement Suite, 2 Attenuators MS464xB-062 – Active Measurement Suite, 4 Attenuators MS4640B-070 – for 70 kHz operation in base VNA MS4640B-002 – for Time Domain MS464xB-031 – Dual Source Architecture MS4640B-035 – IF Digitizer MS4640B-041 – Noise Figure MS4640B-042 – PulseView™ MS4640B-043 – DifferentialView™	MS464xB-031 requires Option 84 or Option 85 For other available options, see “ ME7838G Broadband/Millimeter-Wave System Options ”

Calibration/Verification Kits

- 3659 0.8 mm Calibration/Verification Kit
- 3656B W1 (1.0 mm) Calibration/Verification Kit
- 3656B-3 W1 (1.0 mm) Calibration/Verification Kit, With .s1p Standards Definition Files
- 3655V WR-15 Waveguide Calibration Kit, Without Sliding Loads
- 3655V-1 WR-15 Waveguide Calibration Kit, With Sliding Loads
- 3655E WR-12 Waveguide Calibration Kit, Without Sliding Loads
- 3655E-1 WR-12 Waveguide Calibration Kit, With Sliding Loads
- 3655W WR-10 Waveguide Calibration Kit, Without Sliding Loads
- 3655W-1 WR-10 Waveguide Calibration Kit, With Sliding Loads
- 3650A SMA/3.5 mm Calibration Kit, Without Sliding Loads
- 3650A-1 SMA/3.5 mm Calibration Kit, With Sliding Loads
- 3652A K Calibration Kit, Without Sliding Loads
- 3652A-1 K Calibration Kit, With Sliding Loads
- 3652A-2 K Calibration Kit, Without additional options
- 3652A-3 K Calibration Kit, With Pin Depth Gauge and .s1p Characterization Files
- 3652A-4 K Calibration Kit, With .s1p Characterization Files
- 3654D V Calibration Kit, With Pin Depth Gauge
- 3654D-1 V Calibration Kit, With Pin Depth Gauge and Sliding Loads
- 3654D-2 V Calibration Kit Without additional options
- 3654D-3 V Calibration Kit, With Pin Depth Gauge and .s1p Characterization Files
- 3654D-4 V Calibration Kit, With .s1p Characterization Files
- 3657 V Multi-Line Calibration Kit, Without Shorts
- 3657-1 V Multi-Line Calibration Kit, With Shorts

External Power Meters/Sensors

ML243xA	CW Power Meter, Single Input or Dual Input Recommended Power Sensors: • SC7770 • MA247xD • MA244xD • MA248xD • MA2400xA
ML248xB	Wideband Power Meter, Single Input or Dual Input Recommended Power Sensors: • MA249xA • MA2411B
ML249xA	Pulse Power Meter, Single Input or Dual Input Recommended Power Sensors: • MA249xA • MA2411B
MA24106A	USB Power Sensor, 50 MHz to 6 GHz
MA24108A	USB Power Sensor, 10 MHz to 8 GHz
MA24118A	USB Power Sensor, 10 MHz to 18 GHz
MA24126A	USB Power Sensor, 10 MHz to 26 GHz
MA24330A	USB Power Sensor, 10 MHz to 33 GHz
MA24340A	USB Power Sensor, 10 MHz to 40 GHz
MA24350A	USB Power Sensor, 10 MHz to 50 GHz
MA24507A	Power Master™ Frequency Selectable mm-Wave Power Analyzer, 9 kHz to 70 GHz
MA24510A	Power Master™ Frequency Selectable mm-Wave Power Analyzer, 9 kHz to 110 GHz Note that usage of the MA24507A or MA24510A Power Master™ sensor requires connection to two USB ports to supply needed current draw.

Test Port Cables, Flexible, High Performance

3671W1-50-1	1.0 mm (male) to 1.0 mm (female), 1 each, 10.0 cm (3.9 in)
3671W1-50-2	1.0 mm (male) to 1.0 mm (female), 1 each, 13.0 cm (5.1 in)
3671W1-50-3	1.0 mm (male) to 1.0 mm (female), 1 each, 16.0 cm (6.3 in)
3671KFS50-60	K (female) to 3.5 mm (male) cable, 60 cm (one cable)
3671KFK50-60	K (female) to K (male) cable, 60 cm (one cable)
3671KFK50-100	K (female) to K (male) cable, 1 each, 100 cm (one cable)
3671KFKF50-60	K (female) to K (female) cable, 1 each, 60 cm (one cable)
3671VVF50-60	V (female) to V (male) cable, 1 each, 60 cm (one cable)
3671VVF50-100	V (female) to V (male) cable, 1 each, 100 cm (one cable)
3671KFSF50-60	K (female) to 3.5 mm (female) cable, 1 each, 60 cm (one cable)
3671VVF50-60	V (female) to V (female) cable, 1 each, 60 cm (one cable)
3671VVF50-100	V (female) to V (male) cable, 1 each, 60 cm (one cable)
3670.850-1	0.8 mm (male) to 0.8 mm (female), 1 each, 10.0 cm (3.9 in)
3670.850-2	0.8 mm (male) to 0.8 mm (female), 1 each, 16.0 cm (6.3 in)

Adapters

0.8-105F	0.8 mm (female) Sparkplug Launcher Connector, DC to 145 GHz
0.8-105M	0.8 mm (male) Sparkplug Launcher Connector, DC to 145 GHz
34WV50	1.0 mm (male) to V (male) Adapter, 1.0 mm to V, Coaxial
34WVF50	1.0 mm (male) to V (female) Adapter, 1.0 mm to V, Coaxial
34WV50	1.0 mm (female) to V (male) Adapter, 1.0 mm to V, Coaxial
34WVF50	1.0 mm (female) to V (female) Adapter, 1.0 mm to V, Coaxial
33WW50	1.0 mm (male) to 1.0 mm (male) Adapter, 1.0 mm in-series, Coaxial
33WWF50	1.0 mm (male) to 1.0 mm (female) Adapter, 1.0 mm in-series, Coaxial
33WV50	1.0 mm (female) to 1.0 mm (female) Adapter, 1.0 mm in-series, Coaxial
33WG50	MA25400A Flange Interface to 1 mm (male) Adapter
33.8WG50	MA25400A Flange Interface to 0.8 mm (male) Adapter
35WR5G	MA25400A Flange Interface to WR5 Waveguide Adapter
35WR10W	WR10 to 1.0 mm (male) Adapter, 1.0 mm to WR10 Waveguide
35WR10WF	WR10 to 1.0 mm (female) Adapter, 1.0 mm to WR10 Waveguide
SC7260	WR12 to 1.0 mm (male) Adapter, 1.0 mm to WR12 Waveguide
SC7442	WR12 to 1.0 mm (female) Adapter, 1.0 mm to WR12 Waveguide
35WR15V	WR15 to V (male) Adapter, V (1.85 mm) to WR15 Waveguide
35WR15VF	WR15 to V (female) Adapter, V (1.85 mm) to WR15 Waveguide

For More Information Refer to **Precision RF & Microwave Components Catalog** for descriptions of adapters and other components.

Miscellaneous Components

41W-3	Attenuator, DC to 110 GHz, 0.2 W, 3 dB, W1(m) to W1(f), 50 Ω
41W-6	Attenuator, DC to 110 GHz, 0.2 W, 6 dB, W1(m) to W1(f), 50 Ω
41W-10	Attenuator, DC to 110 GHz, 0.2 W, 10 dB, W1(m) to W1(f), 50 Ω
W240A	Precision Power Divider, DC to 110 GHz, W1(f) input, W1(f) outputs, 3 resistor, 50 Ω
W241A	Precision Power Splitter, DC to 110 GHz, W1(m) input, W1(f) outputs, 2 resistor, 50 Ω
MN25110A	Precision Directional Coupler, 20 GHz to 110 GHz, W1(f) input, W1(f) output, W1(f) coupled port, 50 Ω
33GG50	MA25400 Flange Interface 50 mm Thru Line (male-male)

Accessories

SC8215	Kelvin Bias Tee, 70 kHz to the maximum frequency of the MA25400A module (connects to the SRC port of the module), Max Voltage: 16 VDC, Max Current: 100 mA
SC7287	Kelvin Bias Tee, 100 MHz to the maximum frequency of the MA25400A module (connects to the SRC port of the module), Max Voltage: 50 VDC, Max Current: 500 mA
SC8218	Triax (male) to SMC (male) Cable, (Inner-shield floating at SMC end), 1.5 m (60 in) long two (2) needed per Kelvin Bias Tee
SM6494	System floor console (includes larger size writing table)
2100-1	GPIB cable, 1 m (39 in) long
2100-2	GPIB cable, 2 m (79 in) long
2100-4	GPIB cable, 4 m (157 in) long
806-209-R	Flexible Coaxial Cable, DC to 70 GHz, 36 in (91.5 cm), V(m) – V(f), 50Ω for connecting the VNA and the MA25400A Modules
806-396-R	Flexible Phase Stable Coaxial Cable, DC to 70 GHz, 36 in (91.5 cm), V(m) – V(f), 50Ω for connecting the VNA and the MA25400A Modules
01-201	Torque Wrench (for tightening male devices), 8 mm (5/16 in), 0.9 N·m (8 lbf·in) for SMA, 3.5 mm, 2.4 mm, K, and V connectors
01-202	Universal Test Port Connector Wrench
01-203	Torque Wrench (for tightening the VNA test ports to female devices) 20.6 mm (13/16 in), 0.9 N·m (8 lbf·in)
01-204	Anritsu Stainless Steel Connector Wrench, circular, open-ended for SMA, 3.5 mm, 2.4 mm, K and V connectors
01-504	Torque wrench (for tightening male devices) 6 mm, 0.45 N·m (4 lbf·in) for 1.0 mm and 0.8 mm connectors
01-524	Low profile Torque Wrench (for tightening male devices), 6 mm, 0.45 N·m (4 lbf·in), 126 mm long for 1.0 mm and 0.8 mm connectors
01-529-R	Torque Wrench, 4 mm (5/32 in), 0.17 N·m (1.5 lbf·in) (for tightening the test and reference IF connectors on the mm-Wave modules)

Additional Accessories

	DC-220 GHz probes available from MPI Corporation:
2000-1972-RMPI	T220A-GSG050, 220 GHz Probe, 50 μm pitch
2000-1973-RMPI	T220A-GSG075, 220 GHz Probe, 75 μm pitch
2000-1974-RMPI	T220A-GSG100, 220 GHz Probe, 100 μm pitch

Training at Anritsu

Anritsu has designed courses to help you stay up to date with technologies important to your job. For available training courses, visit: www.anritsu.com/training



• United States

Anritsu Americas Sales Company
450 Century Parkway, Suite 190
Allen, TX 75013, U.S.A.
Phone: +1-800-Anritsu (1-800-267-4878)

• Canada

Anritsu Electronics Ltd.
700 Silver Seven Road, Suite 120
Kanata, Ontario K2V 1C3, Canada
Phone: +1-613-591-2003
Fax: +1-613-591-1006

• Brazil

Anritsu Eletronica Ltda.
Praça Amadeu Amaral, 27 - 1 Andar
01327-010 - Bela Vista - Sao Paulo - SP
Brazil
Phone: +55-11-3283-2511
Fax: +55-11-3288-6940

• Mexico

Anritsu Company, S.A. de C.V.
Blvd Miguel de Cervantes Saavedra #169 Piso 1,
Col. Granada
Mexico, Ciudad de Mexico, 11520, MEXICO
Phone: +52-55-4169-7104

• United Kingdom

Anritsu EMEA L td.
200 Capability Green
Luton, Bedfordshire, LU1 3LU, U.K.
Phone: +44-1582-433200
Fax: +44-1582-731303

• France

Anritsu S.A.
12 avenue du Québec, Bâtiment Iris 1- Silic 612,
91140 Villebon-sur-Yvette, France
Phone: +33-1-60-92-15-50
Fax: +33-1-64-46-10-65

• Germany

Anritsu GmbH
Nemetschek Haus, Konrad-Zuse-Platz 1
81829 München, Germany
Phone: +49-89-442308-0
Fax: +49-89-442308-55

• Italy

Anritsu S.r.l.
Via Elio Vittorini 129, 00144 Roma, Italy
Phone: +39-6-509-9711
Fax: +39-6-502-2425

List Revision Date: 20191126

• Sweden

Anritsu AB
Isafjordsgatan 32C
164 40 Kista, Sweden
Phone: +46-8-534-707-00

• Finland

Anritsu AB
Teknobulevardi 3-5
FI-01530 Vantaa, Finland
Phone: +358-20-741-8100
Fax: +358-20-741-8111

• Denmark

Anritsu A/S
c/o Regus Fairway, Arne Jacobsens Allé 7, 5th floor,
2300 Copenhagen S, Denmark
Phone: +45-7211-2200

• Russia

Anritsu EMEA Ltd.
Representation Office in Russia
Tverskaya str. 16/2, bld. 1, 7th floor
Moscow 125009, Russia
Phone: +7-495-363-1694
Fax: +7-495-935-8962

• Spain

Anritsu EMEA Ltd.
Representation Office in Spain
Paseo de la Castellana, 141.
Planta 5, Edificio Cuzco IV
28046, Madrid, Spain
Phone: +34-91-572-6761

• United Arab Emirates

Anritsu EMEA Ltd.
Dubai Liaison Office
902 Aurora Tower
P O Box: 500311- Dubai Internet City
Dubai, United Arab Emirates
Phone: +971-4-3758479
Fax: +971-4-4249036

• India

Anritsu India Private Limited
6th Floor, Indiqube ETA, No.38/4
Adjacent to EMC2, Doddanekundi, Outer Ring Road
Bengaluru 560048, India
Phone: +91-80-6728-1300
Fax: +91-80-6728-1301

• Singapore

Anritsu Pte. Ltd.
11 Chang Charn Road, #04-01, Shriro House
Singapore 159640
Phone: +65-6282-2400
Fax: +65-6282-2533

• P.R. China (Shanghai)

Anritsu (China) Co., Ltd.
Room 2701-2705, Tower A
New Caohejing International Business Center
No. 391 Gui Ping Road
Shanghai 200233, P.R. China
Phone: +86-21-6237-0898
Fax: +86-21-6237-0899

• P.R. China (Hong Kong)

Anritsu Company Ltd.
Unit 1006-7, 10/F.
Greenfield Tower, Concordia Plaza
No. 1 Science Museum Road
Tsim Sha Tsui East, Kowloon
Hong Kong, P.R. China
Phone: +852-2301-4980
Fax: +852-2301-3545

• Japan

Anritsu Corporation
8-5, Tamura-cho, Atsugi-shi, Kanagawa, 243-0016
Japan
Phone: +81-46-296-6509
Fax: +81-46-225-8352

• South Korea

Anritsu Corporation, Ltd.
5FL, 235 Pangyoeyeok-ro
Bundang-gu, Seongnam-si
Gyeonggi-do 13494, South Korea
Phone: +82-31-696-7750
Fax: +82-31-696-7751

• Australia

Anritsu Pty. Ltd.
Unit 20, 21-35 Ricketts Road
Mount Waverley, Victoria 3149, Australia
Phone: +61-3-9558-8177
Fax: +61-3-9558-8255

• Taiwan

Anritsu Company Inc.
7F, No. 316, Sec. 1, NeiHu Rd. Taipei 114, Taiwan
Phone: +886-2-8751-1816
Fax: +886-2-8751-1817